

CATALOGO POMPE PUMP CATALOGUE

2022

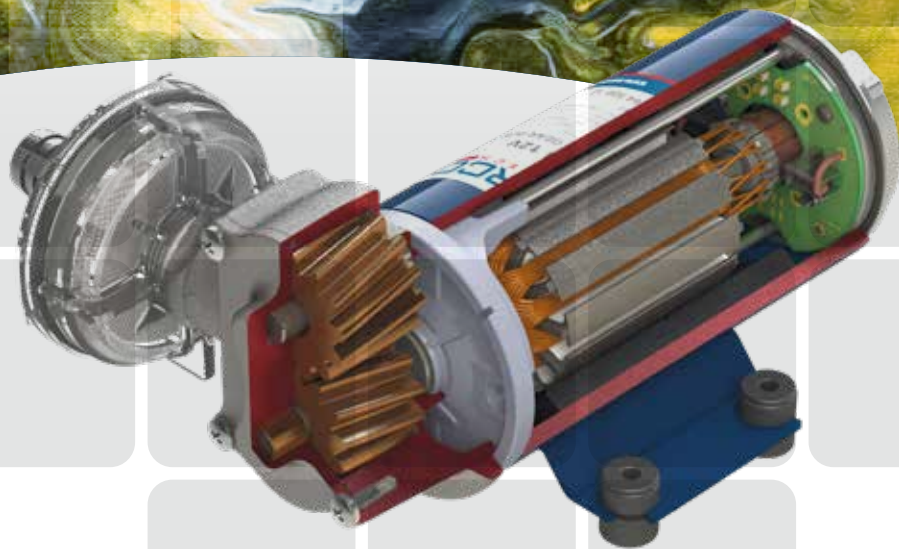

MARCO[®]
FLUID TECH



Company certifications



L'AZIENDA

50 anni di storia aziendale dimostrano la grande capacità di adattamento della MARCO S.p.A. ai mutevoli scenari del tessuto economico mondiale ed al contempo la solidità della propria struttura organizzativa, votata alla crescita e al miglioramento continuo.

Nata nel 1970 come impresa a conduzione familiare, la MARCO S.p.A. è ora una realtà affermata e riconosciuta a livello mondiale, grazie ai continui investimenti nel campo della ricerca tecnologica nel settore delle pompe elettriche e degli avvisatori acustici.

In una sede di 8.000 metri quadrati, l'azienda sviluppa – tramite l'implementazione di sofisticate attrezzature e strumentazioni d'avanguardia – le due core business lines: la produzione di pompe per applicazioni professionali nei settori automotive, industriale e nautico e la fabbricazione di trombe e clacson per auto, camion e imbarcazioni.

I prodotti si contraddistinguono per l'inconfondibile eccellenza Made in Italy e per il contenuto estremamente tecnologico, oltre che per il raggiungimento continuo dei più alti standard di qualità e sicurezza, comprovati dalle numerose omologazioni e certificazioni ISO.

La costante sfida della MARCO nel proporre soluzioni sempre più performanti, le ha permesso di definirsi azienda leader nel proprio settore e di imporsi come interlocutore di riferimento della clientela di 80 Paesi diversi. La propria identità internazionale si è inoltre consolidata con la creazione nel 2010 della filiale americana, MATE USA.

DIE FIRMA

50 Jahre Unternehmensgeschichte zeigen die große Anpassungsfähigkeit von MARCO S.p.A. an die sich ändernden Szenarien der Weltwirtschaft und gleichzeitig die Solidität seiner Organisationsstruktur, die auf kontinuierliches Wachstum und Verbesserung ausgerichtet ist.

MARCO S.p.A. wurde 1970 als Familienunternehmen gegründet und ist heute dank kontinuierlicher Investitionen in die technologische Forschung sowohl auf dem Gebiet der Elektropumpen als auch der Hörner eine etablierte und anerkannte Realität weltweit.

In einer 8.000 Quadratmeter großen Zentrale entwickelt das Unternehmen durch die Implementierung modernster Geräte und Instrumente die beiden Kerngeschäftsbereiche: die Herstellung von Pumpen für professionelle Anwendungen in der Automobil-, Industrie- und Nautikbranche sowie die Herstellung von Hupen für Autos, Lastwagen und Boote.

Die Produktion zeichnet sich durch die unverwechselbare Qualität "Made in Italy" und dem extrem technologischen Inhalt, sowie durch die Einhaltung der höchsten Produktstandards aus, die durch die verschiedenen ISO-Zertifizierungen und Produktzulassungen belegt werden.

Die ständige Herausforderung, immer leistungsfähigere Lösungen vorzuschlagen, hat es MARCO ermöglicht, sich als führenden Marktteilnehmer im internationalen Szenario zu etablieren und seine Marke in über 80 verschiedenen Ländern zu verbreiten.

Darüber hinaus wurde seine internationale Identität 2010 mit der Gründung der amerikanischen Tochtergesellschaft MATE USA festigt.

THE COMPANY

50 years of company history are proof of the great adaptability of MARCO S.p.A. to the changing scenarios of the world economy and at the same time of the solidity of its organizational structure, devoted to continuous growth and improvement.

Founded in 1970 as a family business, MARCO S.p.A. is now an established and recognized reality worldwide, thanks to continuous investments in technological research both in the fields of electric pumps and horns.

In its 8,000 square meter headquarters, the company develops – through the implementation of cutting-edge equipment and instruments – two core business lines: the production of pumps for professional applications in the automotive, industrial and nautical sectors and the manufacture of horns for cars, trucks and boats.

The production is characterized by the unmistakable Made in Italy quality and the extremely technological content, as well as for the compliance to the highest-grade product standards, proven by the various ISO certifications and product approvals.

The constant challenge of proposing increasingly performing solutions has allowed MARCO to establish itself as a leading market player on the international scenario, spreading its brand in over 80 different countries.

Moreover, its international identity was consolidated in 2010 with the foundation of the American subsidiary, MATE USA.

LA MAISON

50 ans d'histoire de l'entreprise démontrent la grande adaptabilité de MARCO S.p.A. aux scénarios changeants de l'économie mondiale et en même temps la solidité de sa structure organisationnelle, vouée à la croissance et à l'amélioration continue.

Fondée en 1970 en tant qu'entreprise familiale, MARCO S.p.A. est aujourd'hui une réalité établie et reconnue dans le monde entier, grâce à des investissements continus dans la recherche technologique tant dans les domaines des pompes électriques que des avertisseurs sonores.

Au sein de son siège social de 8.000 m², l'entreprise développe – à travers la mise en place d'équipements et d'instrumentations de pointe – deux activités principales : la production de pompes à usage professionnel dans les secteurs automobile, industriel et nautique et la fabrication de klaxons pour voitures, camions et bateaux.

Les produits se caractérisent par la qualité incomparable du Made in Italy et le contenu extrêmement technologique, ainsi que par conformité aux normes de produits les plus élevées, prouvées par les différentes homologations et certifications ISO.

Le défi constant de proposer des solutions toujours plus performantes a permis à MARCO de s'imposer comme entreprise leader dans son marché, en diffusant sa marque dans plus de 80 pays différents.

De plus, son identité internationale s'est consolidée en 2010 avec la création de la filiale américaine MATE USA.



LA FIRMA

50 años de trayectoria empresarial demuestran la gran capacidad de adaptación de MARCO S.p.A. a los cambiantes escenarios de la economía mundial y a la vez la solidez de su estructura organizativa, dedicada al crecimiento y mejora continua.

Fundada en 1970 como una empresa familiar, MARCO S.p.A. es ahora una realidad consolidada y reconocida a nivel mundial, gracias a las continuas inversiones en investigación tecnológica tanto en el campo de las bombas eléctricas como de las bocinas.

En su sede de 8.000 metros cuadrados, la empresa desarrolla, a través de la implementación de equipos e instrumentos de última generación, dos líneas de producción fundamentales: la fabricación de bombas para aplicaciones profesionales en los sectores de automoción, industrial y náutico y la producción de bocinas para automóviles, camiones y barcos.

La producción se caracteriza por la inconfundible calidad "Made in Italy" y el contenido extremadamente tecnológico, así como por conformidad con los estándares de productos de más alto grado, comprobados por las diversas certificaciones ISO y aprobaciones de producto.

El desafío constante de proponer soluciones cada vez más eficaces ha permitido a MARCO posicionarse como un actor líder del mercado en el escenario internacional, difundiendo su marca en más de 80 países diferentes.

Además, su identidad internacional se consolidó en 2010 con la fundación de la filial estadounidense MATE USA.

A FIRMA

Os 50 anos de história da empresa são a prova da grande adaptabilidade da MARCO S.p.A. aos cenários de mudança da economia mundial e ao mesmo tempo da solidez da sua estrutura organizacional, vocacionada para o crescimento e a melhoria contínua.

Fundada em 1970 como uma empresa familiar, a MARCO S.p.A. é hoje uma realidade consolidada e reconhecida mundialmente, graças aos contínuos investimentos em pesquisas tecnológicas tanto no campo das bombas elétricas como das buzinas.

Na sua sede de 8.000 metros quadrados, a empresa desenvolve - por meio da implantação de equipamentos e instrumentos de última geração - duas linhas de negócios centrais: a produção de bombas para aplicações profissionais nos setores automotivo, industrial e náutico e a fabricação de buzinas para automóveis, caminhões e barcos.

A produção é caracterizada pela inconfundível qualidade Made in Italy e o conteúdo extremamente tecnológico, bem como pela contínua conformidade com dos mais altos padrões de produtos, comprovados pelas várias certificações ISO e aprovações de produto.

O desafio constante de propor soluções cada vez mais eficientes tem permitido à MARCO se firmar como um player de mercado líder no cenário internacional, divulgando sua marca em mais de 80 países.

Além disso, sua identidade internacional foi consolidada em 2010 com a fundação da subsidiária americana MATE USA.

Partnership



Associated



Associato AIB
Sistema Confindustria

MARCO HIGH TECH REVOLUTION:

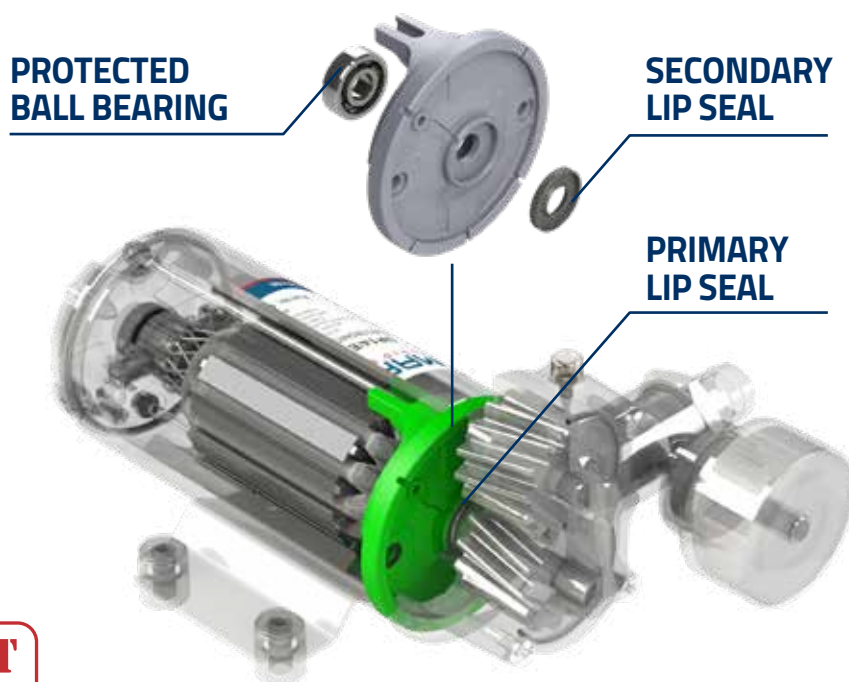

**PATENT
PENDING**

- Motore completamente sigillato e totale assenza di umidità, per una maggior durata delle spazzole e minor consumo elettrico.
- Elevate performance anche in condizioni climatiche di caldo e freddo estremi.
- Ampia tolleranza ai picchi di temperatura del fluido.
- Isolamento termico e meccanico per ridurre l'usura e prolungare la durata delle tenute.
- Alta resistenza ai prodotti chimici.
- Accoppiamento rigido ed allineato tra corpo pompa e motore.
- Sealed and dry motor for extended life of the brushes and lower electrical consumption.
- Enhanced motor protection.
- Best performances both in extreme hot and cold environments.
- Highly extended range of fluid temperature tolerance.
- Thermal and mechanical decoupling for reduced wear and extended seal life.
- Improved resistance to chemicals.
- Locked alignment of pump head.

3 TIMES LONGER OPERATIVE LIFE!

INTEGRATED FLANGE

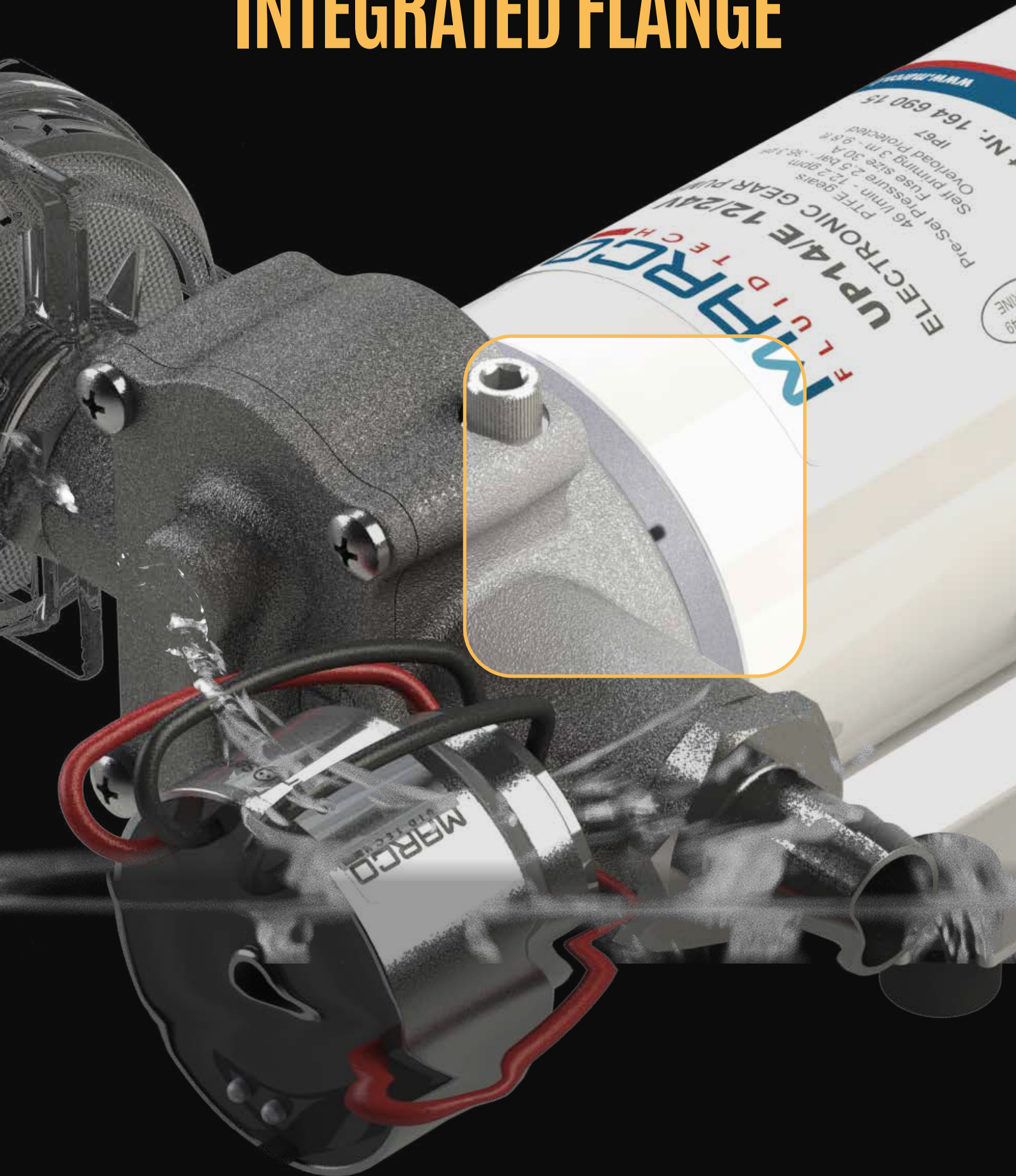

1 DIESEL TRANSFER PUMPS page

BRONZE GEAR PUMPS 8
POMPE AD INGRANAGGI IN BRONZO

12V-24V - DC 9

230V-110V - DC 13

VANE PUMPS 15
POMPE A PALETTE

12V-24V - DC 16

230V - DC 17

2 DIESEL ↔ OIL TRANSFER PUMPS page

12/24V ADJUSTABLE SPEED ELECTRONIC PRESSURE PUMPS 18
POMPE ELETTRONICHE 12/24V A VELOCITÀ REGOLABILE

SCS - SPEED CONTROL SYSTEM 22

12/24V REVERSIBLE ELECTRONIC PUMPS 23
POMPE ELETTRONICHE REVERSIBILI 12/24V

3 OIL TRANSFER PUMPS page

BRONZE GEAR PUMPS 24
POMPE AD INGRANAGGI IN BRONZO

12/24V - DC 25

230V-110V - DC 29

12/24V ELECTRONIC OIL CHANGE KITS 30
KIT CAMBIO OLIO ELETTRONICI 12/24V

RCS - REVERSIBLE CONTROL SYSTEM 32

4

WATER TRANSFER PUMPS

page

ELECTRONIC PRESSURE SENSOR	33
12/24V ELECTRONIC PRESSURE PUMPS <i>AUTOCLAVI ELETTRONICHE 12/24V</i>	34
PCS - PUMP CONTROL SYSTEM	40
12/24V ELECTRONIC PRESSURE PUMP KITS <i>KIT CON POMPE AUTOCLAVI 12/24V</i>	41
POLYMER GEAR PUMPS <i>POMPE AD INGRANAGGI IN POLIMERO</i>	44
12V-24V - DC	45
230V - DC	52
AUTOMATIC PRESSURE PUMPS <i>POMPE AUTOCLAVI</i>	53
12V-24V - DC	53
230V - DC	56
IMPELLER PUMPS <i>POMPE A GIRANTE</i>	58
12V-24V - DC	59
230V-110V - DC	61
SUBMERSIBLE PUMPS <i>POMPE AD IMMERSIONE</i>	62

ACCESSORIES FOR PUMPS <i>ACCESSORI PER POMPE</i>	65
--	----

WARRANTY AND RETURN PROCEDURE <i>GARANZIA E RESI</i>	71
--	----



SELECTION GUIDE TABLES <i>TABELLE DI GUIDA ALLA SCELTA</i>	73-75
--	-------

BRONZE GEAR PUMPS

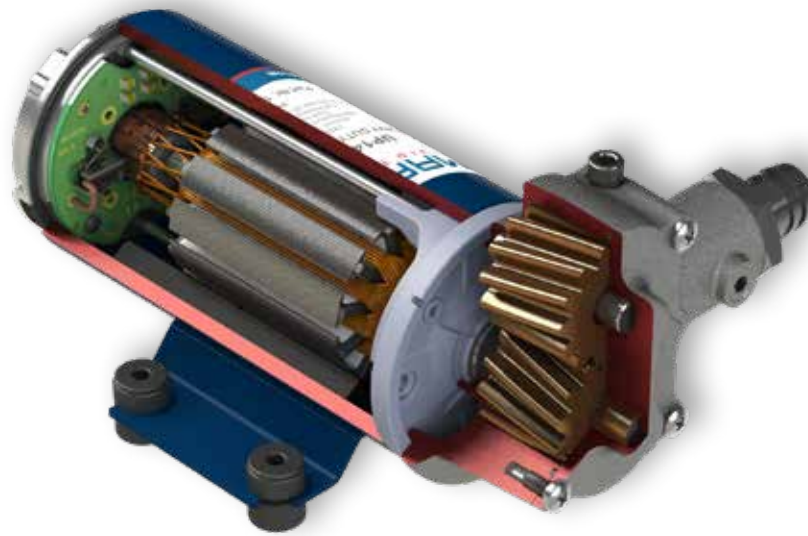

BRONZE GEARS

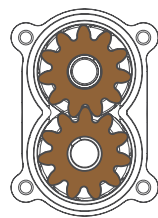

REVERSIBLE



IT Elettropompe autoadescanti di dimensioni compatte con ingranaggi in bronzo per travaso diesel. Gli ingranaggi elicoidali in bronzo garantiscono pressione costante, cicli di lavoro prolungati, maggiore silenziosità e possono operare anche in mancanza di liquido. Corpo in ottone nichelato, albero in acciaio inossidabile. Tenute in FKM e O-ring in NBR. Disponibili in versioni dotate di: carter con maniglia, interruttore o deviatore integrati e controllo elettronico.

DE Kompakte, selbstansaugende Elektropumpe mit Bronzeshnradern zum Umfüllen von Diesel. Die Bronze- Schräg Zahnräder garantieren einen konstanten Druck, verlängerte Arbeitszyklen, sind geräuschärmer und können auch ohne Flüssigkeit arbeiten. Gehäuse aus vernickeltem Messing, Spindel aus rostfreiem Stahl. Dichtungen aus FKM und O-Ring aus NBR. Erhältlich in den Modellen mit Tragetasche, integriertem Schalter oder Wechselschalter und elektronischer Kontrolle.

FR Pompes électriques auto-amorçantes de dimensions réduites avec engrenages en bronze pour transvasement de diesel. Les engrenages hélicoïdaux en bronze assurent une pression constante, des cycles de travail longs, moins de bruit et peuvent également fonctionner en l'absence de liquide. Corps de laiton nickelé, arbre en acier inoxydable, joint en FKM et O-Ring en NBR. Disponibles en versions avec boîtier muni de poignée, avec interrupteur ou déviateur intégrés et avec contrôle électronique.

EN Self-priming electric pumps of compact footprint with bronze gears for diesel transfer. Helical bronze gears guarantee constant pressure, heavy duty cycles, less noise and can operate in the absence of liquid. Body in nickel-plated brass and shaft in stainless steel. FKM seals and NBR O-rings. Available in versions with portable case, integrated on-off switch or flow reverser switch and electronic control.

ES Electrobombas auto cebadas de pequeñas dimensiones con engranajes en bronce para transvase de diésel. Los engranajes helicoidales de bronce garantizan presión constante, largos ciclos de trabajo, menos ruido y pueden operar en ausencia de líquido. Cuerpo en latón niquelado, eje en acero inoxidable. Sellos de FKM y O-ring de NBR. Disponibles en versiones con Kit portable, interruptor o desviador de flujo integrados y control electrónico.

PT Eletrobombas autoaspirantes de pequenas dimensões com engrenagens em bronze para trasfega de diesel. As engrenagens helicoidais de bronze garantem uma pressão constante, longos ciclos de trabalho, menos ruído e também podem funcionar sem líquido. Corpo em latão niquelado, eixo em aço inox. Selos de FKM e O-ring de NBR. Disponíveis em versões com kit portátil, interruptor on-off ou desviador de fluxo integrados e controle eletrônico.

Bronze Gears 12V and 24V - DC

UP2



12V
24V

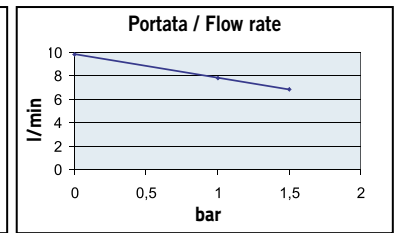
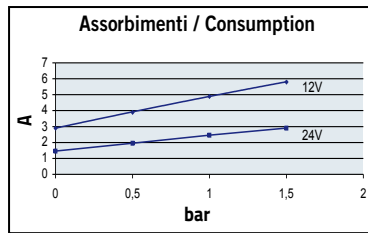
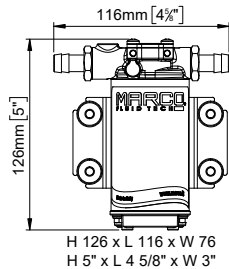

PORTATA FLOW RATE max.	PRESSIONE PRESSURE max.
10 l/min 2.6 gpm	1,5 bar 22 psi

CODICE PART NUMBER	VOLTS	ADESCAM. SELF-PRIM. m	CONS.	MOTORE MOTOR	FUSIBILE FUZE	TUBO TUBE	BOCCHIE PORTS	PESO WEIGHT
164 200 12	12	1,5	3A	90W	5A	12 mm	3/8" BSPP	1,2 kg
164 200 13	24	1,5	1,5A	90W	3A	12 mm	3/8" BSPP	1,2 kg

UP3



12V
24V

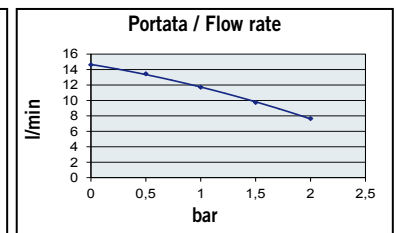
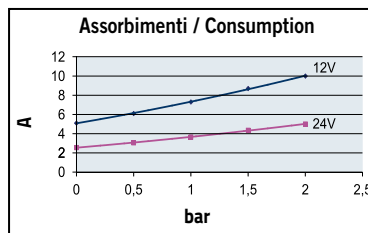
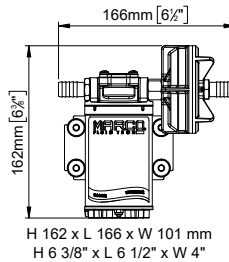

PORTATA FLOW RATE max.	PRESSIONE PRESSURE max.
15 l/min 4 gpm	2 bar 29 psi

CODICE PART NUMBER	VOLTS	ADESCAM. SELF-PRIM. m	CONS.	MOTORE MOTOR	FUSIBILE FUZE	TUBO TUBE	BOCCHIE PORTS	PESO WEIGHT
164 000 12	12	1,5	6A	120W	10A	13 mm	3/8" BSPP	1,4 kg
164 000 13	24	1,5	3A	120W	5A	13 mm	3/8" BSPP	1,4 kg

UP3-CK

■ Portable kit

I
0 On/Off switch



12V
24V

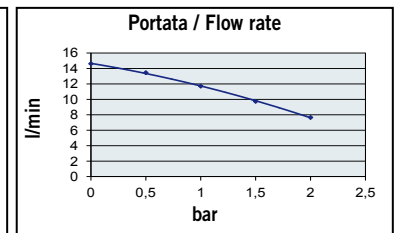
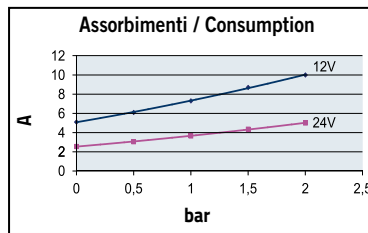
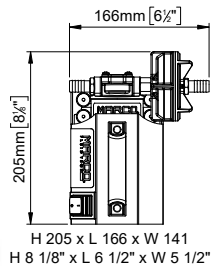

PORTATA FLOW RATE max.	PRESSIONE PRESSURE max.
15 l/min 4 gpm	2 bar 29 psi

CODICE PART NUMBER	VOLTS	ADESCAM. SELF-PRIM. m	CONS.	MOTORE MOTOR	FUSIBILE FUZE	TUBO TUBE	BOCCHIE PORTS	PESO WEIGHT
164 006 12	12	1,5	6A	120W	10A	13 mm	3/8" BSPP	2,8 kg
164 006 13	24	1,5	3A	120W	5A	13 mm	3/8" BSPP	2,8 kg

DIESEL TRANSFER PUMPS

UP3-S

I On/Off switch
0



12V
24V

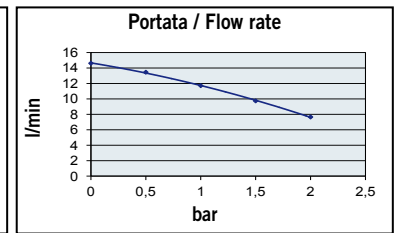
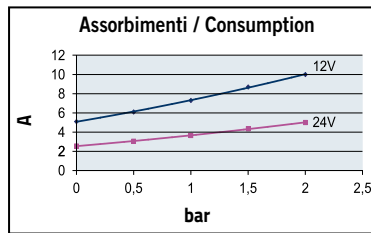
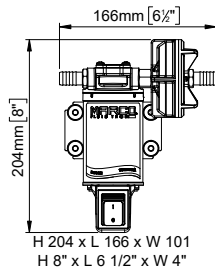

PORTATA FLOW RATE max.	PRESSIONE PRESSURE max.
15 l/min 4 gpm	2 bar 29 psi

CODICE PART NUMBER	VOLTS	ADESCAM. SELF-PRIM. m	CONS.	MOTORE MOTOR	FUSIBILE FUSE	TUBO TUBE	BOCCHIE PORTS	PESO WEIGHT
164 007 12	12	1,5	6A	120W	10A	13 mm	3/8" BSPP	1,8 kg
164 007 13	24	1,5	3A	120W	5A	13 mm	3/8" BSPP	1,8 kg

UP3-R

↕ On/Off 3 positions
reversing switch



12V
24V

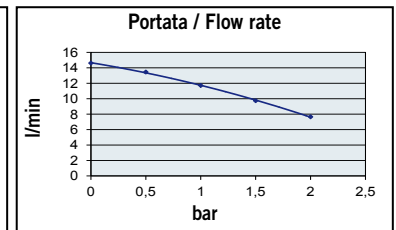
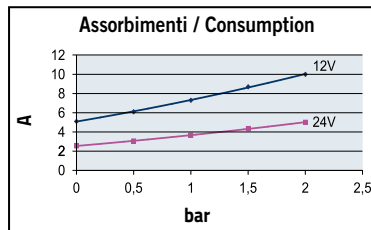
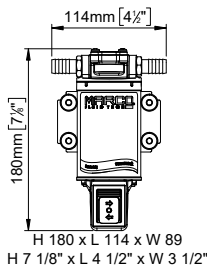

PORTATA FLOW RATE max.	PRESSIONE PRESSURE max.
15 l/min 4 gpm	2 bar 29 psi

CODICE PART NUMBER	VOLTS	ADESCAM. SELF-PRIM. m	CONS.	MOTORE MOTOR	FUSIBILE FUSE	TUBO TUBE	BOCCHIE PORTS	PESO WEIGHT
164 008 12	12	1,5	6A	120W	10A	13 mm	3/8" BSPP	1,8 kg
164 008 13	24	1,5	3A	120W	5A	13 mm	3/8" BSPP	1,8 kg

UP6



12V
24V

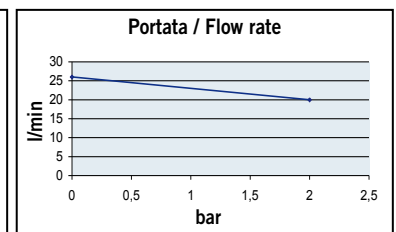
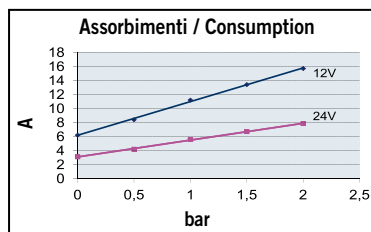
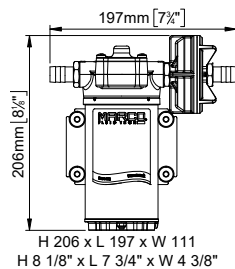

PORTATA FLOW RATE max.	PRESSIONE PRESSURE max.
26 l/min 6.9 gpm	2 bar 29 psi

CODICE PART NUMBER	VOLTS	ADESCAM. SELF-PRIM. m	CONS.	MOTORE MOTOR	FUSIBILE FUSE	TUBO TUBE	BOCCHIE PORTS	PESO WEIGHT
164 060 12	12	2	10A	180W	15A	16 mm	1/2" BSPP	3,2 kg
164 060 13	24	2	5A	180W	7,5A	16 mm	1/2" BSPP	3,2 kg

DIESEL

UP12



12V
24V

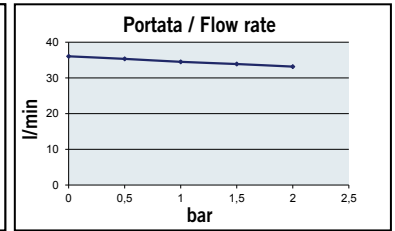
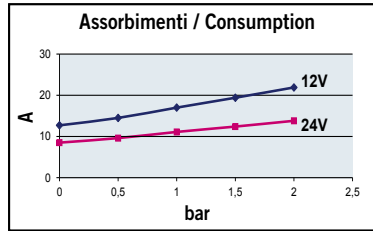
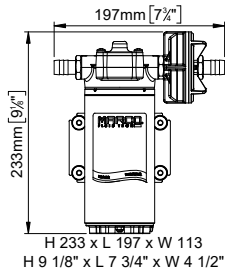

PORTATA
FLOW RATE
max.
36 l/min
9.5 gpm

PRESSIONE
PRESSURE
max.
2 bar
29 psi

CODICE PART NUMBER	VOLTS	ADESCAM. SELF-PRIM. m	CONS.	MOTORE MOTOR	FUSIBILE FUSE	TUBO TUBE	BOCCHIE PORTS	PESO WEIGHT
164 300 12	12	4	14A	360W	20A	16 mm	1/2" BSPP	4,5 kg
164 300 13	24	4	8A	360W	15A	16 mm	1/2" BSPP	4,5 kg

UP14

▪ High flow rate

Link to video
page 69



12V
24V

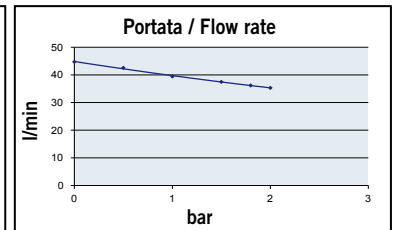
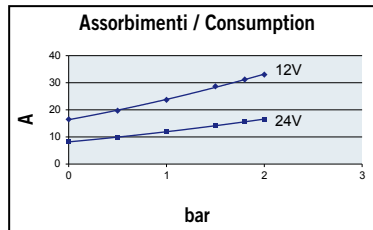
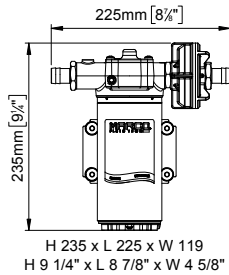

PORTATA
FLOW RATE
max.
46 l/min
12.2 gpm

PRESSIONE
PRESSURE
max.
2 bar
29 psi

CODICE PART NUMBER	VOLTS	ADESCAM. SELF-PRIM. m	CONS.	MOTORE MOTOR	FUSIBILE FUSE	TUBO TUBE	BOCCHIE PORTS	PESO WEIGHT
164 500 12	12	4	16A	400W	30A	19 mm	3/4" BSPP	5,3 kg
164 500 13	24	4	8A	400W	20A	19 mm	3/4" BSPP	5,3 kg

UP8

▪ Heavy duty ▪ Compact footprint



12V
24V

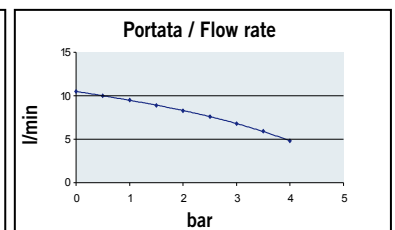
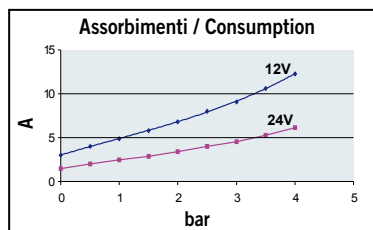
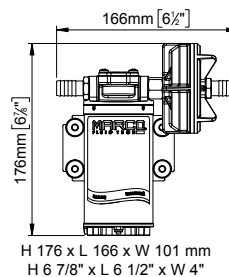

PORTATA
FLOW RATE
max.
10 l/min
2.6 gpm

PRESSIONE
PRESSURE
max.
4 bar
58 psi

CODICE PART NUMBER	VOLTS	ADESCAM. SELF-PRIM. m	CONS.	MOTORE MOTOR	FUSIBILE FUSE	TUBO TUBE	BOCCHIE PORTS	PESO WEIGHT
164 090 12	12	1,5	4A	150W	10A	13 mm	3/8" BSPP	1,8 kg
164 090 13	24	1,5	2A	150W	5A	13 mm	3/8" BSPP	1,8 kg

HIGH PRESSURE

DIESEL TRANSFER PUMPS

UP9



12V
24V

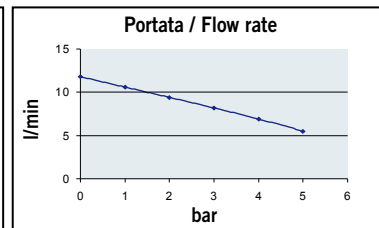
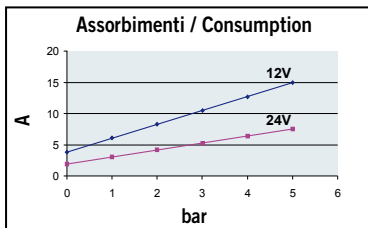
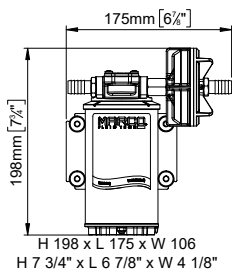

PORTATA
FLOW RATE
max.

PRESSIONE
PRESSURE
max.

12 l/min
3.2 gpm

5 bar
72.5 psi

HIGH PRESSURE

CODICE PART NUMBER	VOLTS	ADESCAM. SELF-PRIM. m	CONS.	MOTORE MOTOR	FUSIBILE FUSE	TUBO TUBE	BOCCHIE PORTS	PESO WEIGHT
164 100 12	12	1,5	5A	180W	15A	13 mm	3/8" BSPP	2,7 kg
164 100 13	24	1,5	3A	180W	7,5A	13 mm	3/8" BSPP	2,7 kg

UP9-HD

▪ Heavy duty



12V
24V

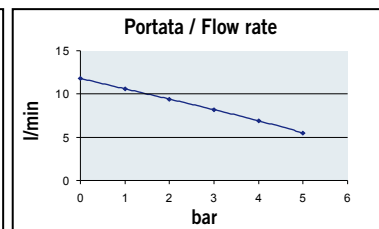
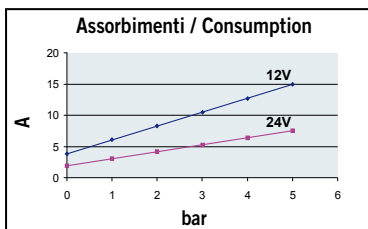
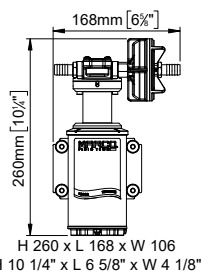

PORTATA
FLOW RATE
max.

PRESSIONE
PRESSURE
max.

12 l/min
3.2 gpm

5 bar
72.5 psi

HIGH PRESSURE

CODICE PART NUMBER	VOLTS	ADESCAM. SELF-PRIM. m	CONS.	MOTORE MOTOR	FUSIBILE FUSE	TUBO TUBE	BOCCHIE PORTS	PESO WEIGHT
164 105 12	12	1,5	5A	180W	15A	13 mm	3/8" BSPP	3 kg
164 105 13	24	1,5	3A	180W	7,5A	13 mm	3/8" BSPP	3 kg

UP10



12V
24V

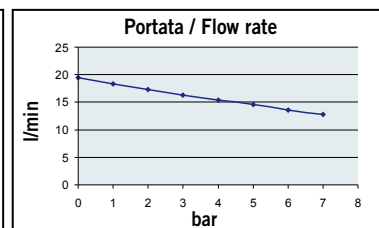
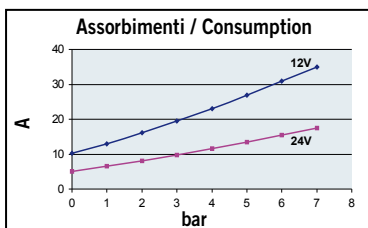
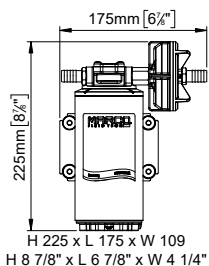

PORTATA
FLOW RATE
max.

PRESSIONE
PRESSURE
max.

18 l/min
4.8 gpm

7 bar
101.5 psi

HIGH PRESSURE

CODICE PART NUMBER	VOLTS	ADESCAM. SELF-PRIM. m	CONS.	MOTORE MOTOR	FUSIBILE FUSE	TUBO TUBE	BOCCHIE PORTS	PESO WEIGHT
164 400 12	12	3	11A	360W	25A	13 mm	3/8" BSPP	3,8 kg
164 400 13	24	3	5A	360W	20A	13 mm	3/8" BSPP	3,8 kg

UP10-HD

■ Heavy duty



12V
24V

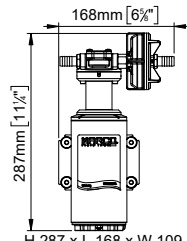

H 287 x L 168 x W 109
H 11 1/4" x L 6 5/8" x W 4 1/4"

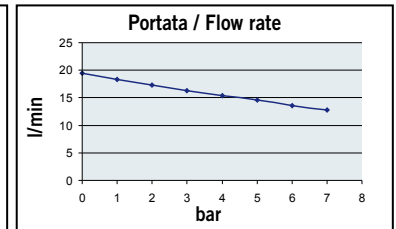
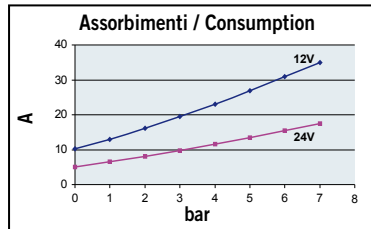

PORTATA FLOW RATE max.	PRESSIONE PRESSURE max.
18 l/min 4.8 gpm	7 bar 101.5 psi
HIGH PRESSURE	

CODICE PART NUMBER	VOLTS	ADESCAM. SELF-PRIM. m	CONS.	MOTORE MOTOR	FUSIBILE FUSE	TUBO TUBE	BOCCHIE PORTS	PESO WEIGHT
164 405 12	12	3	11A	360W	25A	13 mm	3/8" BSPP	4,1 kg
164 405 13	24	3	5A	360W	20A	13 mm	3/8" BSPP	4,1 kg

Bronze Gears 230V and 110V - AC

UP3/AC



230V
110V

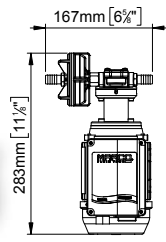

H 283 x L 167 x W 165
H 11 1/8" x L 6 5/8" x W 6 1/2"

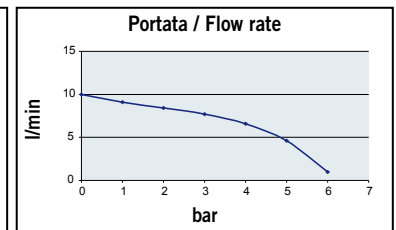
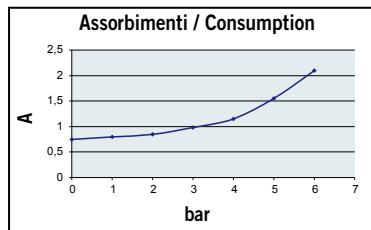

	PORTATA FLOW RATE max.	PRESSIONE PRESSURE max.
230V	10 l/min 2.6 gpm	6 bar 87 psi
110V	12 l/min 3.2 gpm	6 bar 87 psi

CODICE PART NUMBER	VOLT	ADESCAM. SELF-PRIM. m	CONS.	MOTORE MOTOR	FUSIBILE FUSE	TUBO HOSE	BOCCHIE PORTS	PESO WEIGHT
164 001 1C	230	1,5	0,8A	150W	2A	13 mm	3/8" BSPP	4,6 kg
164 001 1B	110	1,5	1,9A	150W	4A	13 mm	3/8" BSPP	4,6 kg

110V VERSION: M.O.Q. 20 PCS

Polymer Gears 110V and 230V - AC

UP6/AC



230V
110V

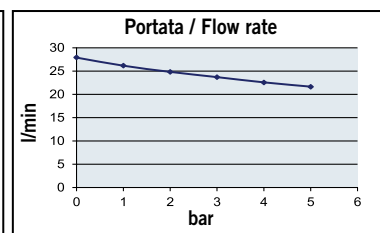
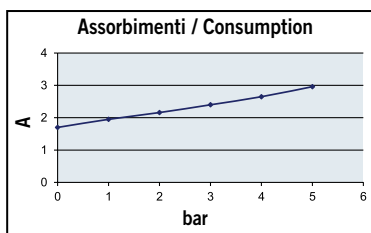
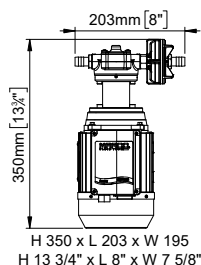

	PORTATA FLOW RATE max.	PRESSIONE PRESSURE max.	CODICE PART NUMBER	VOLT	ADESCAM. SELF-PRIM. m	CONS.	MOTORE MOTOR	FUSIBILE FUZE	TUBO HOSE	BOCCHIE PORTS	PESO WEIGHT
230V	28 l/min 7.4 gpm	5 bar 72.5 psi	164 061 1C	230	1,5	1,7A	550W	3A	16 mm	1/2" BSPP	7,6 kg
110V	34 l/min 9 gpm	5 bar 72.5 psi	164 061 1B	110	1,5	3,8A	550W	5A	16 mm	1/2" BSPP	7,6 kg

110V VERSION: M.O.Q. 20 PCS

UP14/AC

▪ High flow rate



230V
110V

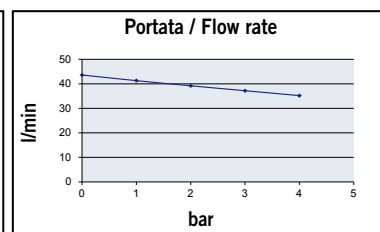
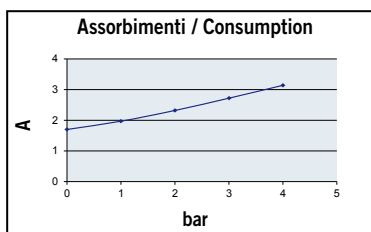
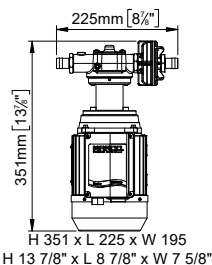

	PORTATA FLOW RATE max.	PRESSIONE PRESSURE max.	CODICE PART NUMBER	VOLT	ADESCAM. SELF-PRIM. m	CONS.	MOTORE MOTOR	FUSIBILE FUZE	TUBO HOSE	BOCCHIE PORTS	PESO WEIGHT
230V	44 l/min 11.6 gpm	4 bar 58 psi	164 540 1C	230	3	1,7A	550W	3A	19 mm	3/4" BSPP	8,1 kg
110V	52,5 l/min 13.9 gpm	4 bar 58 psi	164 540 1B	110	3	3,8A	550W	5A	19 mm	3/4" BSPP	8,1 kg

110V VERSION: M.O.Q. 20 PCS

Vane Pumps



SLIDING VANES



CONNECTION OPTIONS

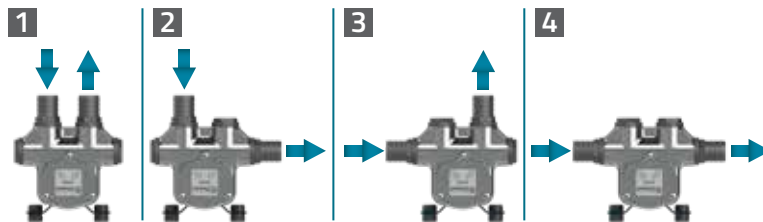

IT Elettropompe autoadescenti a palette, complete di valvola by-pass integrata. Le palette garantiscono alta portata e cicli di lavoro prolungati. Corpo in alluminio con doppia possibilità di connessione per portagomma. Rotore e palette in resina. Albero in acciaio inossidabile. Tenute in FKM e O-ring in NBR. Calotta motore con filtro EMI. Disponibile anche dotata di carter con maniglia per facile trasporto, interruttore on-off e pinze per batteria.

DE Selbstansaugende, Elektro-Schaufelpumpen mit integriertem Bypass-Ventil. Die Schaufeln garantieren für eine erhöhte Leistung und für verlängerte Arbeitszyklen. Aluminiumkörper mit zweifacher Verbindungsmöglichkeit für Schlauchhalter. Rotor und Schaufeln sind aus Harz, Spindel aus rostfreiem Stahl, Dichtungen aus FKM und O-Ring aus NBR. Motordeckel mit EMI-Filter. Auch mit Halterung und Griff für einfachen Transport erhältlich, mit Ein- und Aus-Schalter und Batterieklemmen.

FR Pompes électriques auto-amorçantes à palettes complètes de vanne by-pass intégrée. Les palettes assurent un grand débit et des cycles de travail longs. Corps en aluminium avec double option de connexion pour raccords. Rotor et palettes en résine. Arbre en acier inoxydable, joint en FKM et O-Ring en NBR. Calotte moteur équipée avec filtre EMI. Disponibles aussi avec boîtier muni de poignée pour un transport facile, interrupteur On/Off et pinces pour batterie.

EN Self-priming electric vane pumps with integrated by-pass valve. Vanes guarantee high flow rate and heavy-duty cycles. Aluminum body, two connection options. Rotor and vanes made of resin. Stainless steel shaft. FKM seals and NBR O-rings. Brush holder with EMI filter. Available also with case and handle for easy transport, On/Off switch and battery clips.

ES Electrobombas auto cebadas de paletas con válvula bypass integrada. Las paletas garantizan un caudal grande y largos ciclos de trabajo. Cuerpo en aluminio con doble posibilidad de conexión. Rotor y paletas de resina. Eje en acero inoxidable, sellos de FKM y O-ring de NBR. Tapa del motor con filtro EMI. Disponibles también con cárter y manija para fácil transporte, interruptor On/Off y pinzas para batería.

PT Eletrobombas autoaspirantes de palhetas, completas de válvula by-pass integrada. As palhetas garantem um fluxo muito grande e longos ciclos de trabalho. Corpo em alumínio com dupla possibilidade de ligação. Rotor e palhetas em resina. Eixo em aço inox. Selos de FKM e O-ring de NBR. Calota motor com filtro EMI. Disponíveis também com cárter e empunhadura para fácil transporte, interruptor On/Off e pinças de alimentação.

DIESEL TRANSFER PUMPS

Vane pumps 12V and 24V - DC

VP45-N



12V
24V

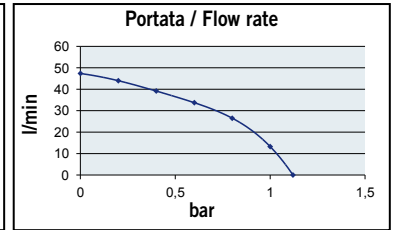
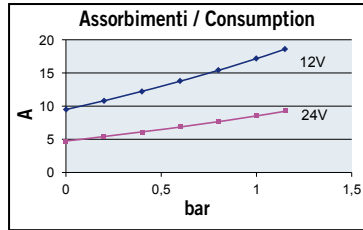
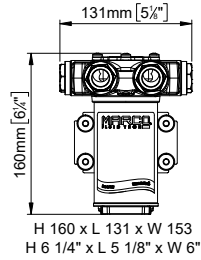

PORTATA FLOW RATE max.	PRESSIONE PRESSURE max.	CODICE PART NUMBER	VOLTS	ADESCAM. SELF-PRIM. m	CONS.	MOTORE MOTOR	FUSIBILE FUSE	TUBO TUBE	BOCCHIE PORTS	PESO WEIGHT
45 l/min 11.9 gpm	1,2 bar 17.4 psi	166 026 12	12	2	8A	150W	20A	25 mm	3/4" BSPP	2 kg
		166 026 13	24	2	4A	150W	10A	25 mm	3/4" BSPP	2 kg

VP45

▪ Portable kit

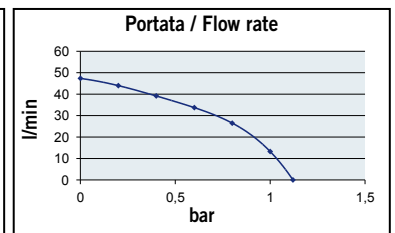
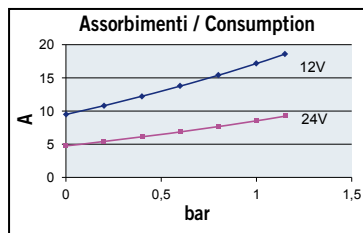
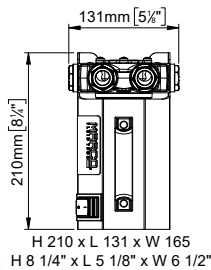

PORTATA FLOW RATE max.	PRESSIONE PRESSURE max.	CODICE PART NUMBER	VOLTS	ADESCAM. SELF-PRIM. m	CONS.	MOTORE MOTOR	FUSIBILE FUSE	TUBO TUBE	BOCCHIE PORTS	PESO WEIGHT
45 l/min 11.9 gpm	1,2 bar 17.4 psi	166 020 12	12	2	8A	150W	20A	25 mm	3/4" BSPP	3,3 kg
		166 020 13	24	2	4A	150W	10A	25 mm	3/4" BSPP	3,3 kg

VP45-S

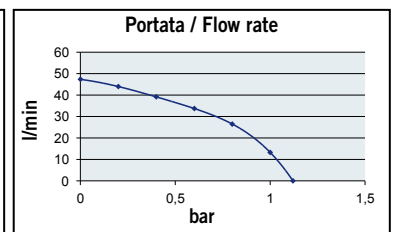
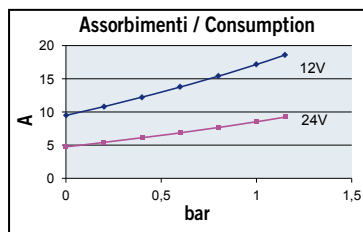
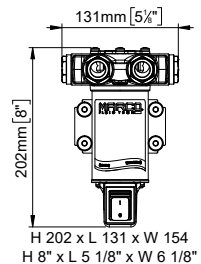

PORTATA FLOW RATE max.	PRESSIONE PRESSURE max.	CODICE PART NUMBER	VOLTS	ADESCAM. SELF-PRIM. m	CONS.	MOTORE MOTOR	FUSIBILE FUSE	TUBO TUBE	BOCCHIE PORTS	PESO WEIGHT
45 l/min 11.9 gpm	1,2 bar 17.4 psi	166 028 12	12	2	8A	150W	20A	25 mm	3/4" BSPP	2,2 kg
		166 028 13	24	2	4A	150W	10A	25 mm	3/4" BSPP	2,2 kg

VP45A-S

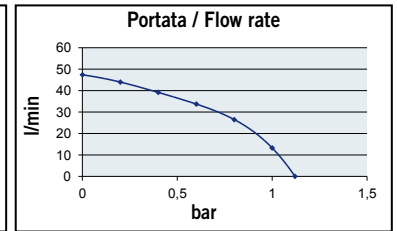
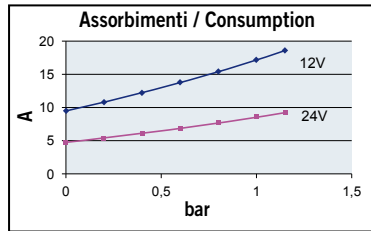
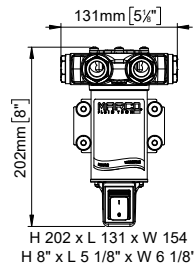

PORTATA FLOW RATE max.	PRESSIONE PRESSURE max.	CODICE PART NUMBER	VOLTS	ADESCAM. SELF-PRIM. m	CONS.	MOTORE MOTOR	FUSIBILE FUSE	TUBO TUBE	BOCCHIE PORTS	PESO WEIGHT
45 l/min 11.9 gpm	1,2 bar 17.4 psi	166 029 12	12	2	8A	150W	20A	20 mm	3/4" BSPP	2,2 kg
		166 029 13	24	2	4A	150W	10A	20 mm	3/4" BSPP	2,2 kg

VP45-K

▪ Complete kit for refueling

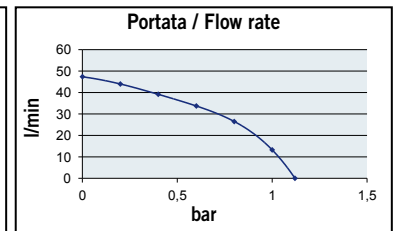
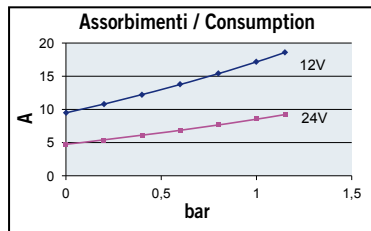
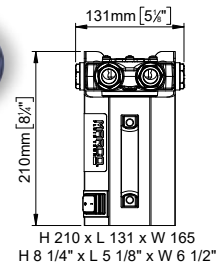

PORTATA FLOW RATE max.	PRESSIONE PRESSURE max.	CODICE PART NUMBER	VOLTS	ADESCAM. SELF-PRIM. m	CONS.	MOTORE MOTOR	FUSIBILE FUSE	TUBO TUBE	BOCCHIE PORTS	PESO WEIGHT
45 l/min 11.9 gpm	1,2 bar 17.4 psi	166 024 12	12	2	8A	150W	20A	25 mm	3/4" BSPP	6,3 kg
		166 024 13	24	2	4A	150W	10A	25 mm	3/4" BSPP	6,3 kg

Vane pumps 230V - AC

VP45/AC

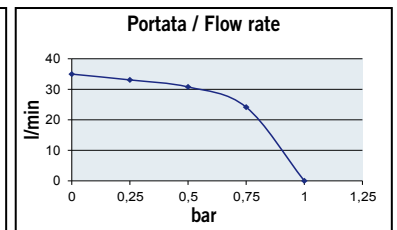
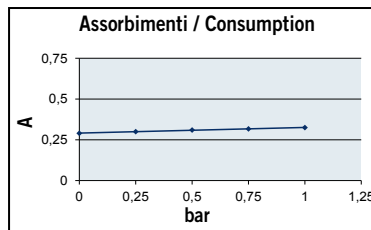
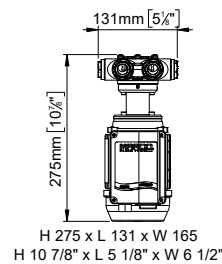

PORTATA FLOW RATE max.	PRESSIONE PRESSURE max.	CODICE PART NUMBER	VOLTS	ADESCAM. SELF-PRIM. m	CONS.	MOTORE MOTOR	FUSIBILE FUSE	TUBO TUBE	BOCCHIE PORTS	PESO WEIGHT
35 l/min 9.2 gpm	1 bar 14.5 psi	166 030 1C	230	1,5	0,8A	150W	1,25A	25 mm	3/4" BSPP	4,7 kg

12/24V Adjustable Speed Electronic PRESSURE PUMPS

SCS Control Panel
see page 22



Electronic Pressure Sensor
see page 33

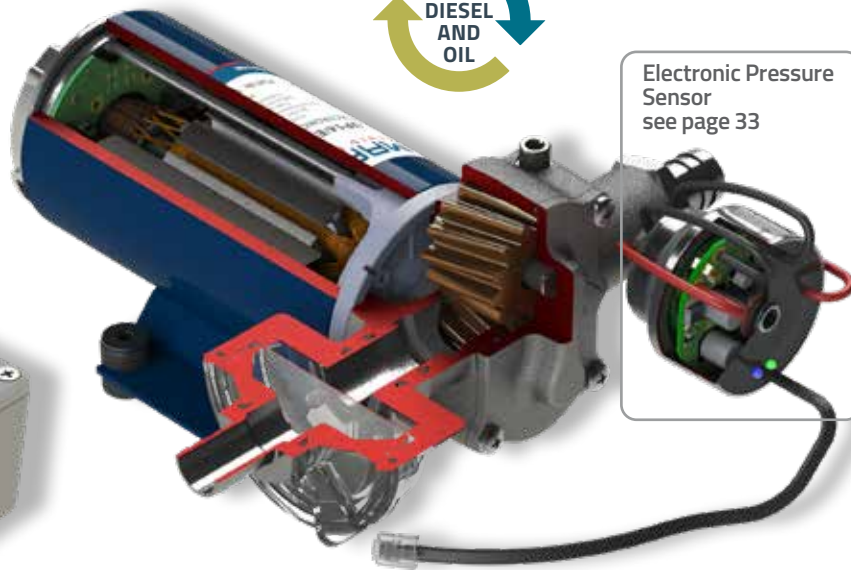

BRONZE GEARS

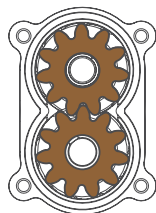

ADJUSTABLE SPEED FOR OILS AND DIESEL

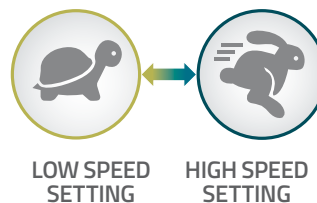

IT Elettropompe automatiche autoadescanti 12/24V con sensore di pressione elettronico per travaso diesel e olio. Ingranaggi in bronzo, valvola di non ritorno in NBR, corpo e connessioni in ottone nichelato, albero in acciaio inossidabile. Tenute in FKM e O-ring in NBR. Gli ingranaggi elicoidali in bronzo garantiscono pressione costante, cicli di lavoro prolungati, maggiore silenziosità e possono operare anche in mancanza di liquido. Impostazione standard dell'elettronica in modalità "High speed" per travaso diesel. Il pannello di controllo SCS integrato consente l'impostazione in modalità "Low Speed" per travaso di olio e liquidi viscosi.

DE Automatische, selbstansaugende Elektropumpen 12/24V mit elektronischem Drucksensor zum Umfüllen von Diesel und Öl. Bronzeshnrad, Rückschlagventil aus NBR, Gehäuse und Verbindungen aus vernickeltem Messing, Spindel aus rostfreiem Stahl. Dichtungen aus FKM und O-Ring aus NBR. Die Bronze- Schrägzahnäder garantieren für einen konstanten Druck, für längere Arbeitszyklen, für Geräuschreduzierung und können auch ohne Flüssigkeit arbeiten. Elektronische Standardeinstellung im "High Speed"-Modus beim Umfüllen von Diesel. Das integrierte Kontrollpaneel SCS, ermöglicht einen "Low-Speed"-Modus beim Umfüllen von Ölen und anderen zähflüssigen Flüssigkeiten.

FR Pompes électriques automatiques auto-amorçantes 12/24V avec contrôle électronique pour le transfert de diesel et huile. Vanne anti-retour en NBR, corps et raccords en laiton nickelé, arbre en acier inoxydable, joint en FKM et O-Ring en NBR. Les engrenages hélicoïdaux en bronze assurent une pression constante, des cycles de travail longs, moins de bruit et peuvent également fonctionner en l'absence de liquide. La pompe est réglée en mode "High Speed" pour le transfert de diesel. Le panneau de contrôle SCS intégré permet la mise en "Low Speed" pour le transfert de huile et de liquides visqueux.

EN Self-priming automatic electric pumps, 12/24V, with electronic control for the transfer of diesel and oil. Bronze gears, NBR check valve, body and connections in nicked brass, stainless steel shaft. FKM seals and NBR O-rings. Helical bronze gears guarantee constant pressure, heavy duty cycles, less noise and can operate in the absence of liquid. The pumps are supplied with a "High-Speed" setting for Diesel transfer. **The integrated SCS control panel allows the switch to the "Low-Speed" mode for the transfer of oil and viscous liquids.**

ES Electrobombas automáticas auto-cebadas, 12/24V, con control electrónico para transvase de diésel y aceite. Engranajes de bronce, válvula de retención de NBR, cuerpo y conexiones en latón niquelado, eje en acero inoxidable. Sellos de FKM y O-ring de NBR. Los engranajes helicoidales de bronce garantizan presión constante, largos ciclos de trabajo, menos ruido y pueden operar en ausencia de líquido. La electrónica está configurada en modalidad "High Speed" para el transvase de diésel. **El panel de control SCS integrado permite el cambio a la modalidad "Low Speed" para transvase de aceite y líquidos viscosos.**

PT Electrobombas automáticas autoaspirantes, 12/24V, com controle eletrônico para trasfega de diesel e óleos. Engrenagens em bronze, válvula de retenção em NBR, corpo e ligações em latão niquelado, eixo em aço inox. Selos de FKM e O-ring de NBR. As engrenagens helicoidais de bronze garantem uma pressão constante, longos ciclos de trabalho, menos ruído e também podem funcionar sem líquido. As bombas são fornecidas na modalidade "High Speed" para trasfega do diesel. **O painel de controle SCS integrado permite a mudança para a modalidade "Low Speed" para a trasfega de óleos e líquidos viscosos.**

12/24V Adjustable Speed Electronic PRESSURE PUMPS

UP2/E-BR

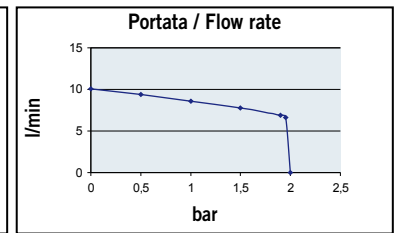
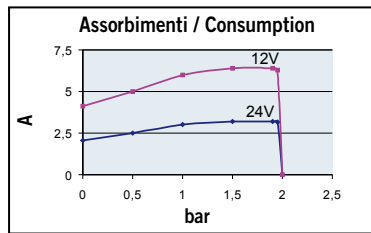
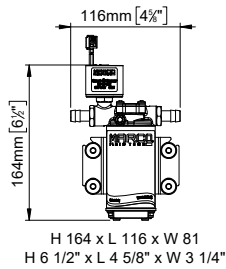

12/24V

PORTATA
FLOW RATE
max.
10 l/min
2.6 gpm

PRESSIONE
PRESSURE
max.
2 bar
29 psi

CODICE PART NUMBER	VOLTS	ADESCAM. SELF-PRIM. m	CONS.	MOTORE MOTOR	FUSIBILE FUSE	TUBO TUBE	BOCCHIE PORTS	PESO WEIGHT
164 700 15	12/24	1,5	3A / 1,5A	90W	7,5A	12 mm	3/8" BSPP	1,3 kg

UP3/E-BR

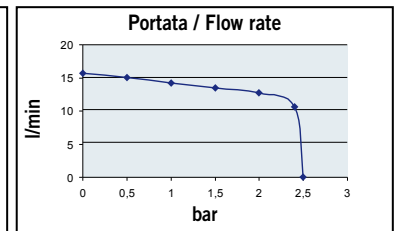
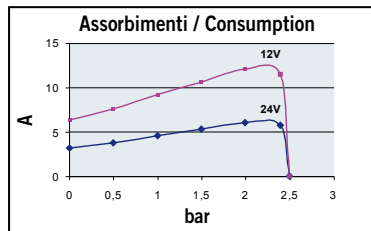
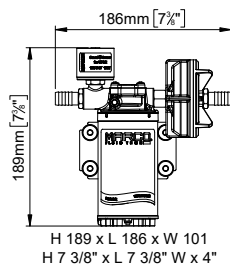

12/24V

PORTATA
FLOW RATE
max.
15 l/min
4 gpm

PRESSIONE
PRESSURE
max.
2,5 bar
36 psi

CODICE PART NUMBER	VOLTS	ADESCAM. SELF-PRIM. m	CONS.	MOTORE MOTOR	FUSIBILE FUSE	TUBO TUBE	BOCCHIE PORTS	PESO WEIGHT
164 710 15	12/24	1,5	6A / 3A	150W	15A	13 mm	3/8" BSPP	2 kg

UP6/E-BR

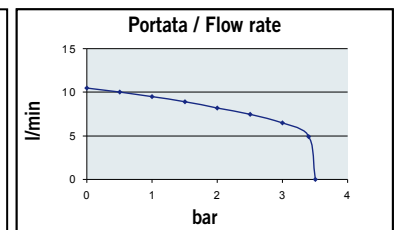
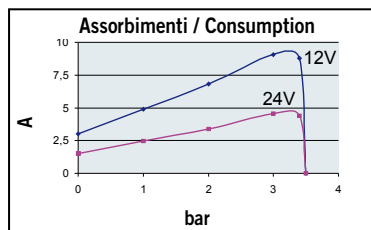
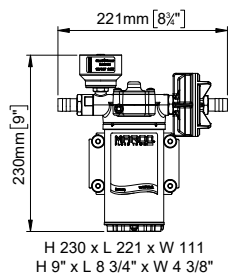

12/24V

PORTATA
FLOW RATE
max.
26 l/min
6.9 gpm

PRESSIONE
PRESSURE
max.
2,5 bar
36 psi

CODICE PART NUMBER	VOLTS	ADESCAM. SELF-PRIM. m	CONS.	MOTORE MOTOR	FUSIBILE FUSE	TUBO TUBE	BOCCHIE PORTS	PESO WEIGHT
164 720 15	12/24	2	10A / 5A	180W	20A	16 mm	1/2" BSPP	3,7 kg

UP12/E-LOBR



12/24V

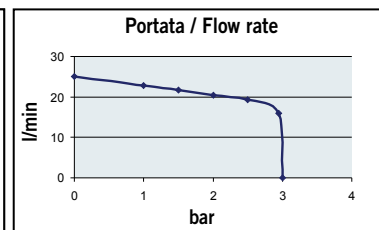
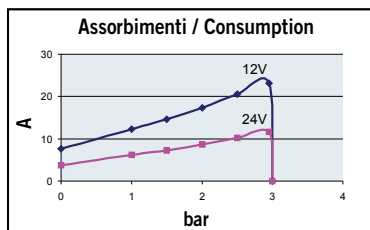
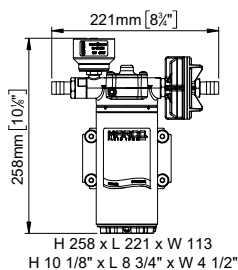

PORTATA FLOW RATE max.	PRESSIONE PRESSURE max.
26 l/min 6.9 gpm	3 bar 43.5 psi

CODICE PART NUMBER	VOLTS	ADESCAM. SELF-PRIM. m	CONS.	MOTORE MOTOR	FUSIBILE FUZE	BOCCHE PORTS	PESO WEIGHT
164 751 15	12/24	3	8A / 4A	360W	25A	1/2" BSPP	4,6 kg

UP12/E-BR



12/24V

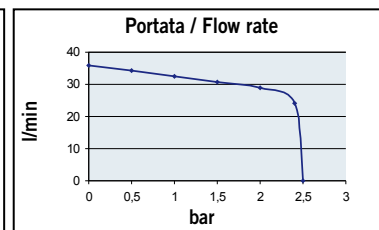
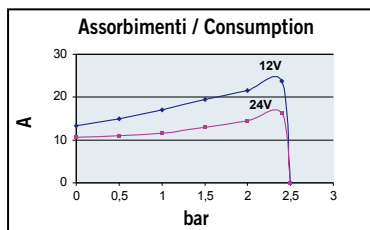
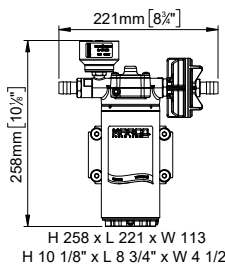

PORTATA FLOW RATE max.	PRESSIONE PRESSURE max.
36 l/min 9.5 gpm	2,5 bar 36 psi

CODICE PART NUMBER	VOLTS	ADESCAM. SELF-PRIM. m	CONS.	MOTORE MOTOR	FUSIBILE FUZE	TUBO TUBE	BOCCHE PORTS	PESO WEIGHT
164 750 15	12/24	3	14A / 7A	360W	25A	16 mm	1/2" BSPP	4,9 kg

UP14/E-BR



12/24V

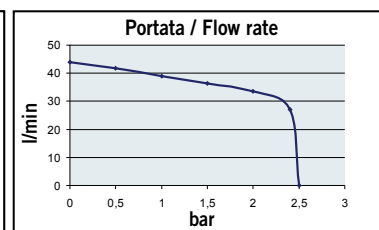
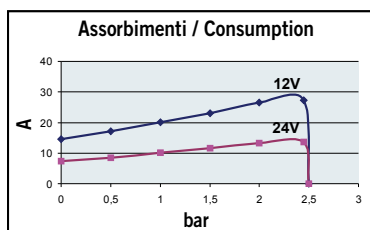
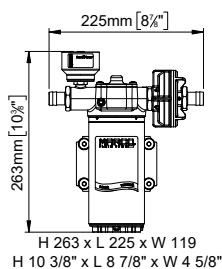

PORTATA FLOW RATE max.	PRESSIONE PRESSURE max.
46 l/min 12 gpm	2,5 bar 36 psi

CODICE PART NUMBER	VOLTS	ADESCAM. SELF-PRIM. m	CONS.	MOTORE MOTOR	FUSIBILE FUZE	BOCCHE PORTS	PESO WEIGHT
164 760 15	12/24	4	16A / 8A	400W	30A	3/4" BSPP	5,2 kg

UP8/E-BR



12/24V

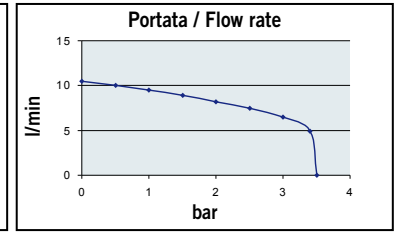
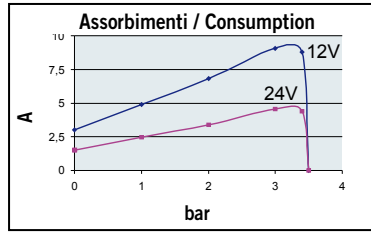
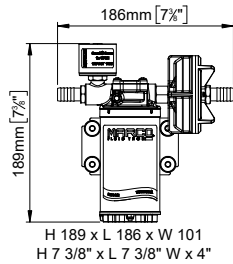

PORTATA FLOW RATE max.	PRESSIONE PRESSURE max.
10 l/min <i>2.6 gpm</i>	3,5 bar <i>50.8 psi</i>
HIGH PRESSURE	

CODICE PART NUMBER	VOLTS	ADESCAM. SELF-PRIM. m	CONS.	MOTORE MOTOR	FUSIBILE FUSE	TUBO TUBE	BOCCHIE PORTS	PESO WEIGHT
164 725 15	12/24	1,5	4A / 2A	150W	15A	13 mm	3/8" BSPP	2,1 kg

UP9/E-BR



12/24V

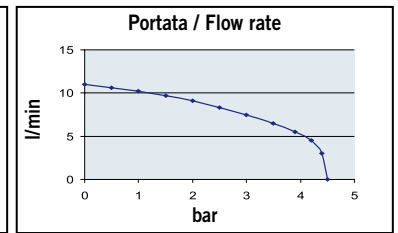
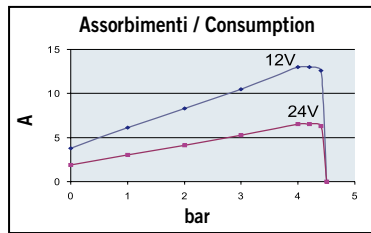
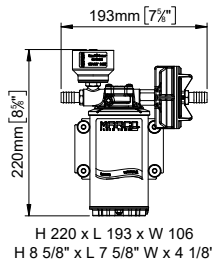

PORTATA FLOW RATE max.	PRESSIONE PRESSURE max.
12 l/min <i>3.2 gpm</i>	4,5 bar <i>65.3 psi</i>
HIGH PRESSURE	

CODICE PART NUMBER	VOLTS	ADESCAM. SELF-PRIM. m	CONS.	MOTORE MOTOR	FUSIBILE FUSE	TUBO TUBE	BOCCHIE PORTS	PESO WEIGHT
164 730 15	12/24	1,5	5A / 2,5A	180W	15A	13 mm	3/8" BSPP	3,3 kg

UP10/E-BR



12/24V

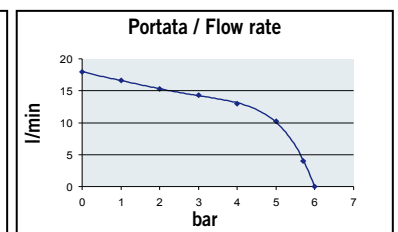
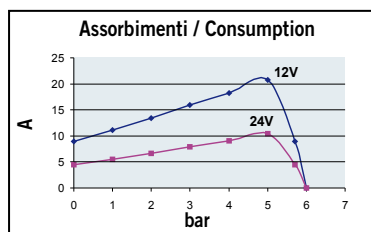
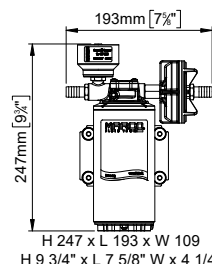

PORTATA FLOW RATE max.	PRESSIONE PRESSURE max.
18 l/min <i>4.8 gpm</i>	6 bar <i>87 psi</i>
HIGH PRESSURE	

CODICE PART NUMBER	VOLTS	ADESCAM. SELF-PRIM. m	CONS.	MOTORE MOTOR	FUSIBILE FUSE	TUBO TUBE	BOCCHIE PORTS	PESO WEIGHT
164 740 15	12/24	3	11A / 5,5A	360W	25A	13 mm	3/8" BSPP	4,3 kg

12/24V REVERSIBLE Electronic Pumps

UP8-RE

Smart Keypad



▪ Integrated Smart Keypad for Flow Rate Fine Tuning

VIDEO [Link to video page 69](#)



12/24V

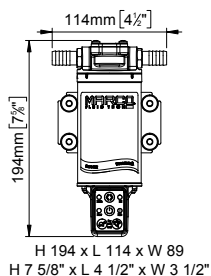

H 194 x L 114 x W 89
H 7 5/8" x L 4 1/2" x W 3 1/2"

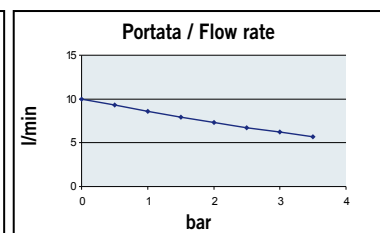
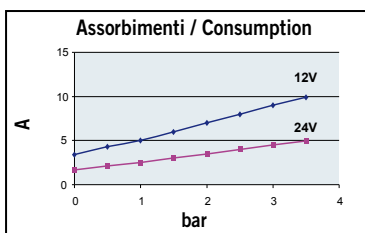

PORTATA
FLOW RATE
max.

PRESSIONE
PRESSURE
max.

10 l/min
2.6 gpm

3,5 bar
50.8 psi

HIGH PRESSURE

CODICE PART NUMBER	VOLTS	ADESCAM. SELF-PRIM. m	CONS.	MOTORE MOTOR	FUSIBILE FUSE	TUBO TUBE	BOCCHE PORTS	PESO WEIGHT
164 095 15	12/24	1,5	4A / 2A	150W	15A	13 mm	3/8" BSPP	2,2 kg

UP3-RK

RCS Panel see page 32



▪ Available with 1 or 2 valves



(see page 68)



12/24V

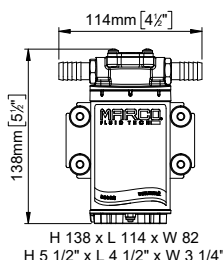

H 138 x L 114 x W 82
H 5 1/2" x L 4 1/2" x W 3 1/4"

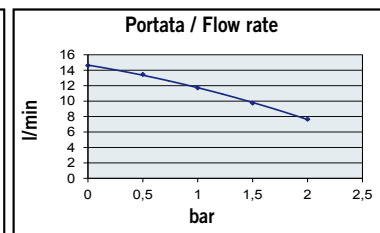
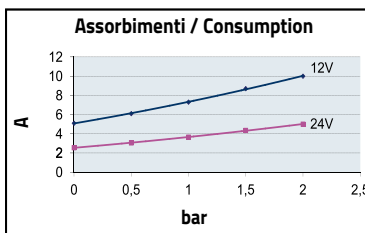

PORTATA
FLOW RATE
max.

PRESSIONE
PRESSURE
max.

15 l/min
4 gpm

2 bar
29 psi

CODICE PART NUMBER	VOLTS	ADESCAM. SELF-PRIM. m	CONS.	MOTORE MOTOR	FUSIBILE FUSE	TUBO TUBE	BOCCHE PORTS	PESO WEIGHT
164 005 15	12/24	1,5	6A / 3A	120W	10A	13 mm	3/8" BSPP	2,1 kg

UP6-RK

RCS Panel see page 32



▪ Available with 1 or 2 valves



(see page 68)



12/24V

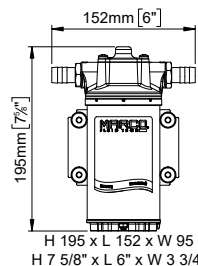

H 195 x L 152 x W 95
H 7 5/8" x L 6" x W 3 3/4"

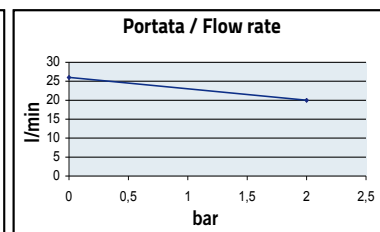
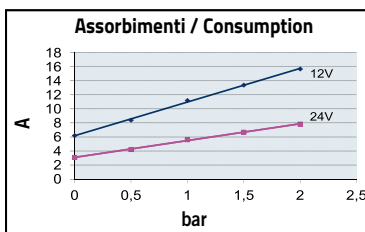

PORTATA
FLOW RATE
max.

PRESSIONE
PRESSURE
max.

20 l/min
5.3 gpm

2 bar
29 psi

CODICE PART NUMBER	VOLTS	ADESCAM. SELF-PRIM. m	CONS.	MOTORE MOTOR	FUSIBILE FUSE	TUBO TUBE	BOCCHE PORTS	PESO WEIGHT
164 064 15	12/24	2	7A / 3,5A	180W	10A	16 mm	1/2" BSPP	3,6 kg

BRONZE GEAR PUMPS

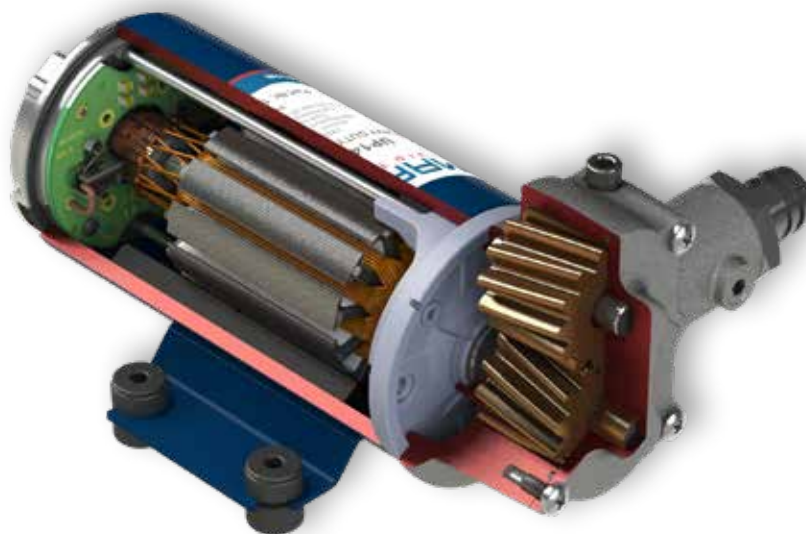

BRONZE GEARS

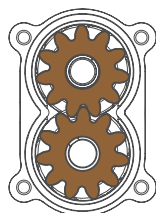

REVERSIBLE



IT Elettropompe ad ingranaggi in bronzo per travaso di oli lubrificanti o di liquidi viscosi. Gli ingranaggi elicoidali in bronzo garantiscono pressione costante, cicli di lavoro prolungati, maggiore silenziosità e possono operare anche in mancanza di liquido. Corpo in ottone nichelato, albero in acciaio inossidabile. Tenute in FKM e O-ring in NBR. Disponibili in versioni con interruttore o deviatore integrati, kit con interruttore cavi e pinze per batteria e kit con controllo elettronico.

DE Selbstansaugende, kleine Elektropumpen mit Bronzeshnradern, zum Umfüllen von Ölen oder dickflüssigen Flüssigkeiten. Die Bronze- Schräg Zahnräder garantieren konstanten Druck, verlängerte Arbeitszyklen, sind geräuschloser und können auch ohne Flüssigkeit arbeiten. Gehäuse aus vernickeltem Messing, Spindel aus rostfreiem Stahl. Dichtungen aus FKM, O-Ringe aus NBR. Erhältlich entweder mit integriertem Ein- und Aus Schalter oder 3-Positionen- Schalter, oder Kit mit Schalter, Kabel und Batterie zangen, oder Kit mit elektronischer Kontrolle.

FR Pompes électriques auto-amorçantes avec engrenages en bronze pour transvasement d'huiles lubrifiants et de liquides visqueux. Les engrenages hélicoïdaux en bronze assurent une pression constante, des cycles de travail longs, moins de bruit et peuvent également fonctionner en l'absence de liquide. Corps en laiton nickelé et arbre en acier inoxydable. Joint en FKM et O-Ring en NBR. Disponibles en versions avec interrupteur ou déviateur intégrés, kit avec interrupteur et pinces pour batterie, et kit avec contrôle électronique.

EN Self-priming electric pumps with bronze gears to transfer lubricating oils and viscous liquids. Helical bronze gears guarantee constant pressure, heavy duty cycles, less noise and can operate in the absence of liquid. Nickel-plated brass body and stainless steel shaft. FKM seals and NBR O-rings. Available in versions with integrated on-off switch or flow reverser switch, kit with on-off switch and battery clips, and kit with electronic control.

ES Electrobombas auto cebadas con engranajes en bronce para transvase aceites lubricantes o líquidos viscosos. Los engranajes helicoidales de bronce garantizan presión constante, largos ciclos de trabajo, menos ruido y pueden operar en ausencia de líquido. Cuerpo en latón niquelado, eje en acero inoxidable. Sellos en FKM y O-ring and NBR. Disponibles en versiones con interruptor o desviador de flujo integrados, Kit con interruptor y pinzas para batería y Kit con control electrónico.

PT Eletrobombas autoaspirantes com engrenagens em bronze para trasfega de óleos lubrificantes e líquidos viscosos. As engrenagens helicoidais de bronze garantem uma pressão constante, longos ciclos de trabalho, menos ruído e também podem funcionar, sem líquido. Corpo em latão niquelado, eixo em aço inox. Selos de FKM e O-ring de NBR. Disponíveis em versões com interruptor on-off ou desviador de fluxo integrados, kit com interruptor e pinças de bateria, e kit com controle eletrônico.

Spare parts and accessories

Page 68

OK1



Bronze Gears 12V and 24V - DC

UP2/OIL



12V
24V

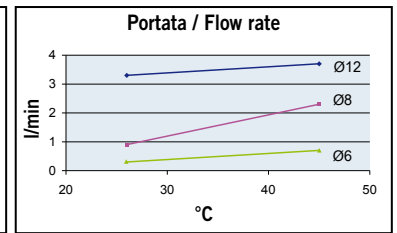
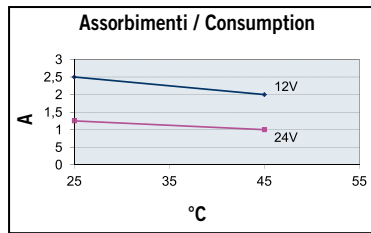
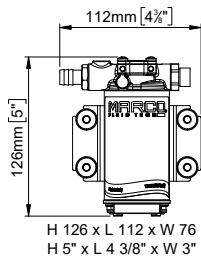

PORTATA*
FLOW RATE*
max.

PRESSIONE
PRESSURE
max.

3,3 l/min
0.9 gpm

1,5 bar
22 psi

* OIL SAE 30 AT 25°C

CODICE PART NUMBER	VOLTS	ADESCAM. SELF-PRIM. m	CONS.	MOTORE MOTOR	FUSIBILE FUSE	TUBO TUBE	BOCCHIE PORTS	PESO WEIGHT
164 220 12	12	1	2,5A	90W	3A	12 mm	3/8" BSPP	1,2 kg
164 220 13	24	1	1,3A	90W	1,5A	12 mm	3/8" BSPP	1,2 kg

UP3/OIL



12V
24V

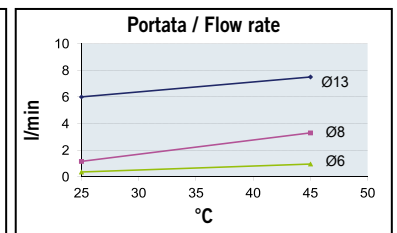
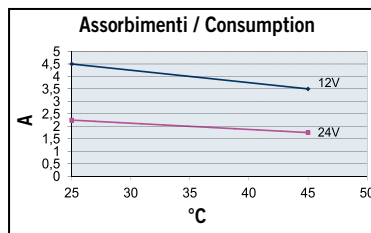
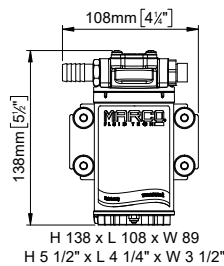

PORTATA*
FLOW RATE*
max.

PRESSIONE
PRESSURE
max.

5,5 l/min
1.5 gpm

2 bar
29 psi

* OIL SAE 30 AT 25°C

CODICE PART NUMBER	VOLTS	ADESCAM. SELF-PRIM. m	CONS.	MOTORE MOTOR	FUSIBILE FUSE	TUBO TUBE	BOCCHIE PORTS	PESO WEIGHT
164 020 12	12	1	5A	90W	7,5A	13 mm	3/8" BSPP	1,4 kg
164 020 13	24	1	3A	90W	4A	13 mm	3/8" BSPP	1,4 kg

UP3/OIL-R



On/Off 3 positions
reversing switch



12V
24V

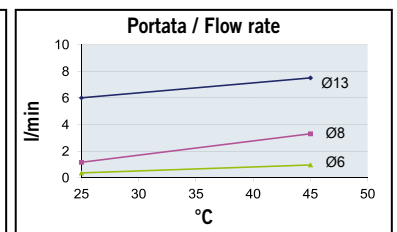
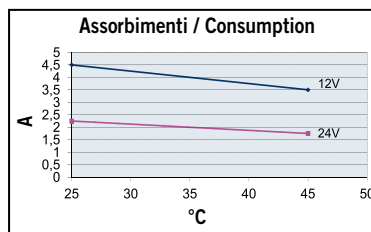
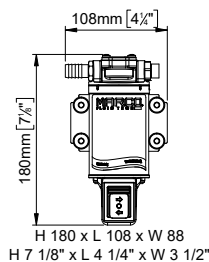

PORTATA*
FLOW RATE*
max.

PRESSIONE
PRESSURE
max.

5,5 l/min
1.5 gpm

2 bar
29 psi

* OIL SAE 30 AT 25°C

CODICE PART NUMBER	VOLTS	ADESCAM. SELF-PRIM. m	CONS.	MOTORE MOTOR	FUSIBILE FUSE	TUBO TUBE	BOCCHIE PORTS	PESO WEIGHT
164 022 12	12	1	5A	90W	7,5A	13 mm	3/8" BSPP	1,8 kg
164 022 13	24	1	3A	90W	4A	13 mm	3/8" BSPP	1,8 kg

OIL TRANSFER PUMPS

OCK1

▪ Complete kit with battery clips



12V
24V

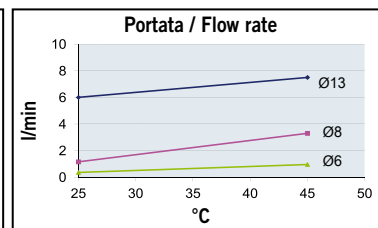
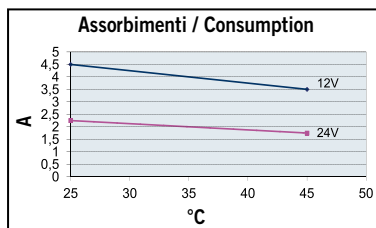
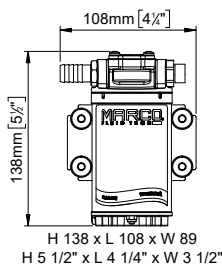

PORTATA*
FLOW RATE*
max.

PRESSIONE
PRESSURE
max.

5,5 l/min
1.5 gpm

2 bar
29 psi

* OIL SAE 30
AT 25°C

CODICE PART NUMBER	VOLTS	ADESCAM. SELF-PRIM. m	CONS.	MOTORE MOTOR	FUSIBILE FUSE	TUBO TUBE	BOCCHIE PORTS	PESO WEIGHT
164 930 12	12	1	6A	90W	10A	13 mm	3/8" BSPP	1,7 kg
164 930 13	24	1	3A	90W	5A	13 mm	3/8" BSPP	1,7 kg

OCK1-R

▪ Complete kit with battery clips

On/Off 3 positions
reversing switch



12V
24V

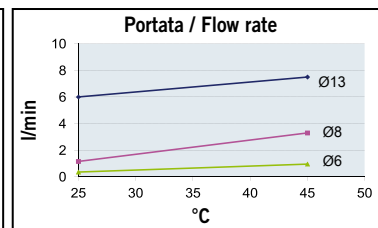
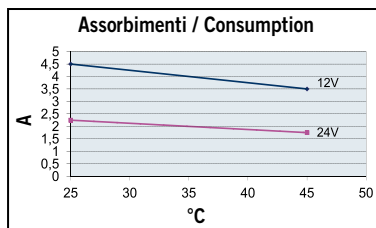
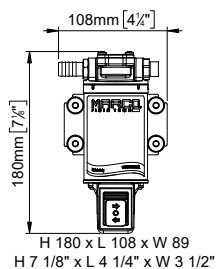

PORTATA*
FLOW RATE*
max.

PRESSIONE
PRESSURE
max.

5,5 l/min
1.5 gpm

2 bar
29 psi

* OIL SAE 30
AT 25°C

CODICE PART NUMBER	VOLTS	ADESCAM. SELF-PRIM. m	CONS.	MOTORE MOTOR	FUSIBILE FUSE	TUBO TUBE	BOCCHIE PORTS	PESO WEIGHT
164 932 12	12	1	5A	90W	10A	13 mm	3/8" BSPP	1,4 kg
164 932 13	24	1	3A	90W	5A	13 mm	3/8" BSPP	1,4 kg

UP6/OIL



12V
24V

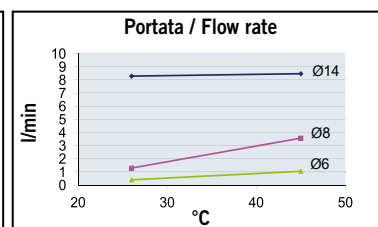
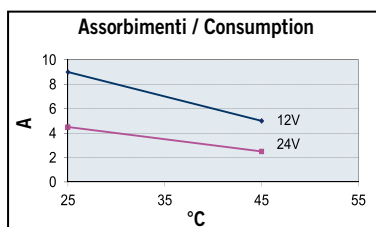
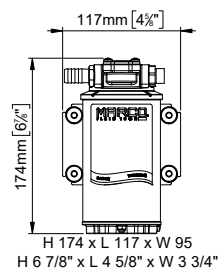

PORTATA*
FLOW RATE*
max.

PRESSIONE
PRESSURE
max.

8 l/min
2.1 gpm

5 bar
72.5 psi

* OIL SAE 30
AT 25°C

HIGH PRESSURE

CODICE PART NUMBER	VOLTS	ADESCAM. SELF-PRIM. m	CONS.	MOTORE MOTOR	FUSIBILE FUSE	TUBO TUBE	BOCCHIE PORTS	PESO WEIGHT
164 080 12	12	1,5	7A	180W	10A	13 mm	3/8" BSPP	2,5 kg
164 080 13	24	1,5	4A	180W	7,5A	13 mm	3/8" BSPP	2,5 kg

UP12/OIL



12V
24V

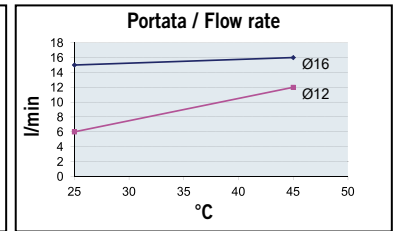
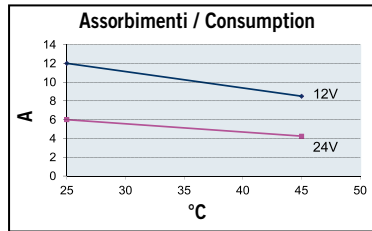
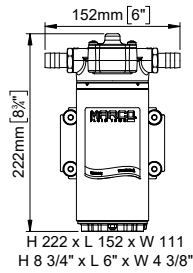

PORTATA*
FLOW RATE*
max.

PRESSIONE
PRESSURE
max.

15 l/min
4 gpm

3 bar
43.5 psi

* OIL SAE 30
AT 25°C

CODICE PART NUMBER	VOLTS	ADESCAM. SELF-PRIM. m	CONS.	MOTORE MOTOR	FUSIBILE FUSE	TUBO TUBE	BOCCHIE PORTS	PESO WEIGHT
164 320 12	12	2	11A	180W	15A	16 mm	1/2" BSPP	4,5 kg
164 320 13	24	2	6A	180W	7,5A	16 mm	1/2" BSPP	4,5 kg

UP12-LO

▪ For light oils



12V
24V

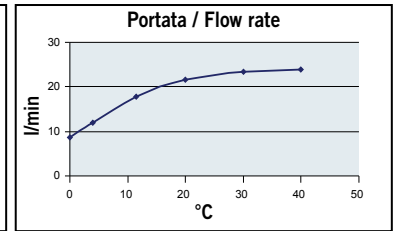
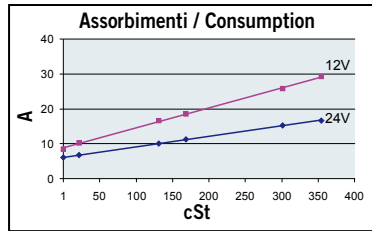
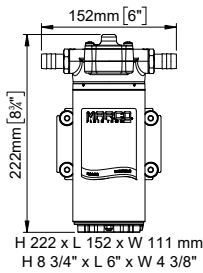

PORTATA**
FLOW RATE**
max.

PRESSIONE
PRESSURE
max.

22 l/min
5.8 gpm

3 bar
43.5 psi

** T46 OIL

CODICE PART NUMBER	VOLTS	ADESCAM. SELF-PRIM. m	CONS.	MOTORE MOTOR	FUSIBILE FUSE	TUBO TUBE	BOCCHIE PORTS	PESO WEIGHT
164 322 12	12	3	19A	360W	25A	16 mm	1/2" BSPP	4,5 kg
164 322 13	24	3	11A	360W	15A	16 mm	1/2" BSPP	4,5 kg

UP12-LOCK

▪ For light oils ▪ Portable kit with battery clips

I
0 On/Off switch



12V
24V

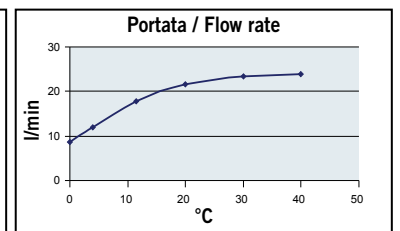
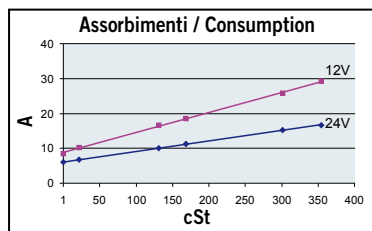
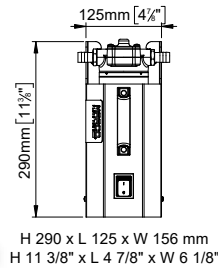

PORTATA**
FLOW RATE**
max.

PRESSIONE
PRESSURE
max.

22 l/min
5.8 gpm

3 bar
43.5 psi

** T46 OIL

CODICE PART NUMBER	VOLTS	ADESCAM. SELF-PRIM. m	CONS.	MOTORE MOTOR	FUSIBILE FUSE	TUBO TUBE	BOCCHIE PORTS	PESO WEIGHT
164 324 12	12	3	19A	360W	25A	16 mm	1/2" BSPP	4,5 kg
164 324 13	24	3	11A	360W	15A	16 mm	1/2" BSPP	4,5 kg

OIL TRANSFER PUMPS

UP14/OIL



12V
24V

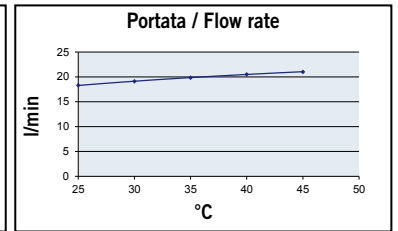
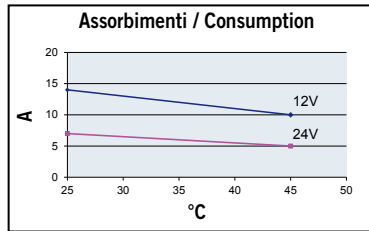
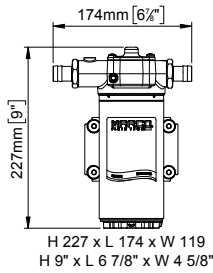

PORTATA*
FLOW RATE*
max.

18,3 l/min
4.8 gpm

PRESSIONE
PRESSURE
max.

2 bar
29 psi

* OIL SAE 30
AT 25°C

CODICE PART NUMBER	VOLTS	ADESCAM. SELF-PRIM. m	CONS.	MOTORE MOTOR	FUSIBILE FUSE	TUBO TUBE	BOCCHIE PORTS	PESO WEIGHT
164 520 12	12	2	14A	260W	20A	20 mm	3/4" BSPP	5,3 kg
164 520 13	24	2	7A	260W	15A	20 mm	3/4" BSPP	5,3 kg

Flexible Impeller 12V and 24V - DC

UP1-J/OIL

- FKM Impeller
- Low speed
- Special for oil change

NEW



12V
24V

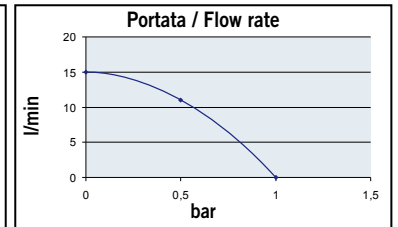
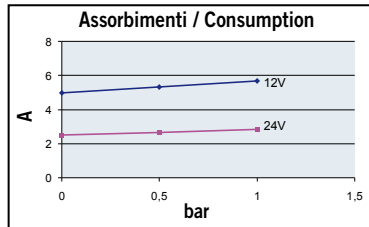
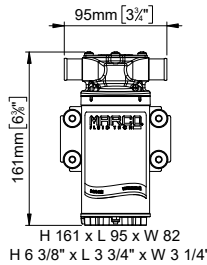

PORTATA*
FLOW RATE*
max.

15 l/min
4 gpm

PRESSIONE
PRESSURE
max.

1 bar
14.5 psi

* OIL SAE 30 AT 25°C

CODICE PART NUMBER	VOLTS	ADESCAM. SELF-PRIM. m	CONS.	MOTORE MOTOR	FUSIBILE FUSE	TUBO TUBE	BOCCHIE PORTS	PESO WEIGHT
162 005 12	12	1	5A	120W	7,5A	20 mm	3/8" BSPP	1,8 kg
162 005 13	24	1	2,5A	120W	4A	20 mm	3/8" BSPP	1,8 kg

Bronze Gears 230V and 400V - AC

UP6/OIL-AC

NEW



230V
400V

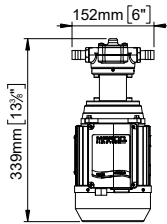

H 339 x L 152 x W 195
H 13 3/8" x L 6" x W 7 5/8"

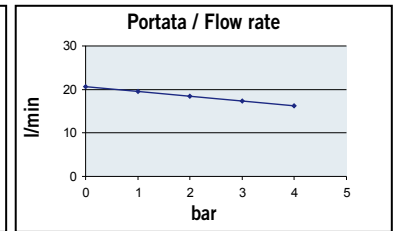
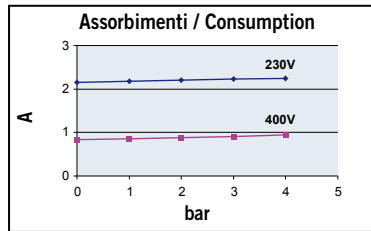

PORTATA
FLOW RATE
max.

PRESSIONE
PRESSURE
max.

CODICE
PART NUMBER

VOLT

ADESCAM.
SELF-PRIM.
m

CONS.

MOTORE
MOTOR

FUSIBILE
FUSE

TUBO
HOSE

BOCCH
PORTS

PESO
WEIGHT

230V

14 l/min
3.7 gpm

5 bar
72.5 psi

164 081 1C

230

1

2A

370W

3A

16 mm

1/2" BSPP

7,6 kg

400V

14 l/min
3.7 gpm

5 bar
72.5 psi

164 081 1F

400

1,5

0,8A

370W

1A

16 mm

1/2" BSPP

7,6 kg

UP14/OIL-AC

NEW



230V
400V

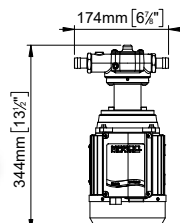

H 344 x L 174 x W 195
H 13 1/2" x L 6 7/8" x W 7 5/8"

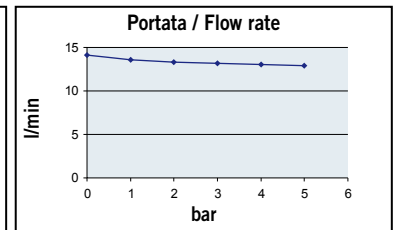
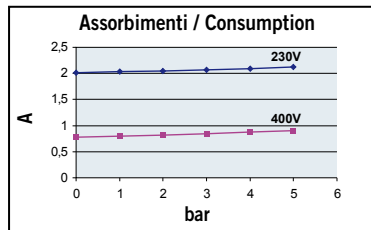

PORTATA
FLOW RATE
max.

PRESSIONE
PRESSURE
max.

CODICE
PART NUMBER

VOLT

ADESCAM.
SELF-PRIM.
m

CONS.

MOTORE
MOTOR

FUSIBILE
FUSE

TUBO
HOSE

BOCCH
PORTS

PESO
WEIGHT

230V

21 l/min
5.5 gpm

4 bar
58 psi

164 521 1C

230

2

2,1A

370W

3A

19 mm

3/4" BSPP

8,1 kg

400V

21 l/min
5.5 gpm

4 bar
58 psi

164 521 1F

400

2

0,8A

370W

1A

19 mm

3/4" BSPP

8,1 kg

OIL

12/24V Electronic Oil Change Kits

IT Pompe e sistemi reversibili con controllo elettronico per operazioni di travaso e cambio olio. Il controllo elettronico regola la velocità del motore della pompa in base alla viscosità/temperatura dell'olio e aumenta il numero di giri nella fase di adescamento per maggiore rapidità dell'operazione. Il sistema va in blocco automatico in caso di fine liquido, cortocircuito e dopo 30 minuti di operatività.

DE Pumpen und reversible Systeme mit elektronischer Kontrolle zum Umfüllen und Wechsel von Öl. Automatische Geschwindigkeitsregulierung des Motors je nach Dickflüssigkeit/Temperatur des Öles. Um die Ansaugphase zu verkürzen, wird die Drehzahl erhöht. Das System wird automatisch blockiert bei Fehlen der Flüssigkeit, bei Kurzschluss und nach 30 Minuten Arbeitszeit.

FR Pompes et systèmes réversibles avec contrôle électronique pour vidanger et changer l'huile. Le contrôle électronique règle la vitesse du moteur selon la viscosité/température de l'huile et de plus augmente le numéro de tours-moteur dans la phase d'amorçage pour une rapidité opérative. Le système est bloqué automatiquement en cas de réservoir vide, court-circuit et après 30 min. de fonctionnement.

EN Reversible electronic pumps and systems for oil fill and drain operations. The electronic control adjusts the speed of the motor according to oil viscosity/temperature and increases its speed during priming for faster operations. The system automatically shuts off in case of empty tank, short circuit and after 30 minutes of operation.

ES Bombas y sistemas reversibles con control electrónico para el vaciado/llenado de aceite. El control electrónico adapta la velocidad del motor a la viscosidad/temperatura del aceite. También aumenta la velocidad de la bomba en fase de cebadura para mejorar la velocidad de las operaciones. El sistema se para automáticamente en caso de tanque vacío, cortocircuito y después de 30 minutos de trabajo.

PT Bombas e sistemas reversíveis com controle eletrônico para o rápido esvaziamento e enchimento do óleo. O controle eletrônico regula a velocidade do motor conforme a viscosidade/temperatura do óleo, além disso aumenta o número das voltas na fase de aspiração para uma maior velocidade operativa. O sistema entra em bloqueio automático no caso do líquido acabar ou de curto-circuito, e depois de 30 min. de trabalho.

Spare parts and accessories

OCP1/3

OCP2/3

OCP1/6

OCP2/6



Page 68

OCK8-E

Smart Keypad

- Integrated Smart Keypad for fine tuning
- Reversible

- Complete kit with battery clips

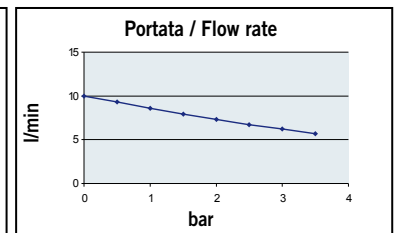
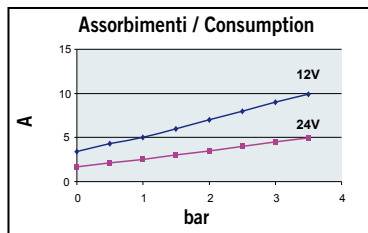
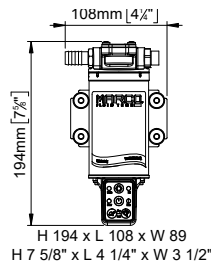

PORTATA FLOW RATE max.	PRESSIONE PRESSURE max.
10 l/min 2.6 gpm	3,5 bar 50.8 psi
	HIGH PRESSURE

CODICE PART NUMBER	VOLTS	ADESCAM. SELF-PRIM. m	CONS.	MOTORE MOTOR	FUSIBILE FUSE	TUBO TUBE	BOCCHIE PORTS	PESO WEIGHT
164 936 15	12/24	1,5	4A / 2A	150W	15A	13 mm	3/8" BSPP	2,2 kg

OCK1-E

- Reversible
- Complete kit with battery clips

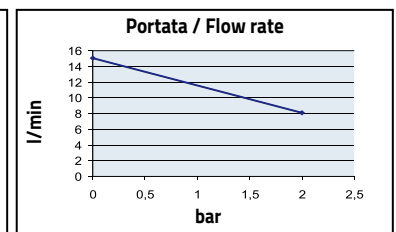
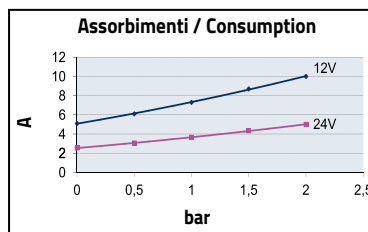
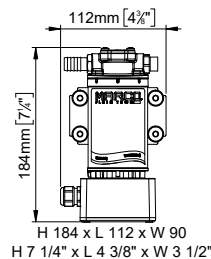

PORTATA FLOW RATE max.	PRESSIONE PRESSURE max.
15 l/min 4 gpm	2 bar 29 psi

CODICE PART NUMBER	VOLT	ADESCAM. SELF-PRIM. m	CONS.	MOTORE MOTOR	FUSIBILE FUSE	TUBO HOSE	BOCCHIE PORTS	PESO WEIGHT
164 931 15	12/24	1	6A / 3A	120W	7,5A	13 mm	3/8" BSPP	2,4 kg

OCS3/E

- 3 valves
- Reversible



12/24V

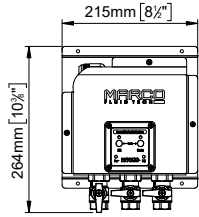

H 264 x L 215 x W 114
H 10 3/8" x L 8 1/2" x W 4 1/2"

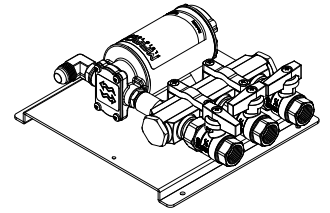

PORTATA FLOW RATE max.	PRESSIONE PRESSURE max.
10 l/min 2.6 gpm	2 bar 29 psi

CODICE PART NUMBER	VOLTS	ADESCAM. SELF-PRIM. m	CONS.	MOTORE MOTOR	FUSIBILE FUSE	BOCCHIE PORTS	PESO WEIGHT
164 924 15	12/24	1,5	4A / 2A	120W	10A	1/2" BSPP	4,4 kg

OCS5/E

- 5 valves
- Reversible



12/24V

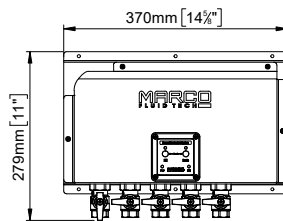

H 279 x L 370 x W 124
H 11" x L 14 5/8" x W 4 7/8"

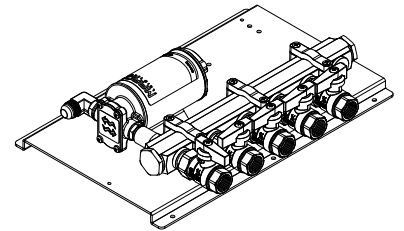

PORTATA FLOW RATE max.	PRESSIONE PRESSURE max.
10 l/min 2.6 gpm	2 bar 29 psi

CODICE PART NUMBER	VOLTS	ADESCAM. SELF-PRIM. m	CONS.	MOTORE MOTOR	FUSIBILE FUSE	BOCCHIE PORTS	PESO WEIGHT
164 925 15	12/24	1,5	4A / 2A	120W	10A	1/2" BSPP	6,5 kg

OCS6/E

- 6 valves
- Reversible



12/24V

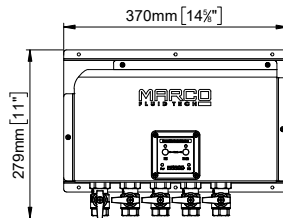

H 279 x L 370 x W 124
H 11" x L 14 5/8" x W 4 7/8"

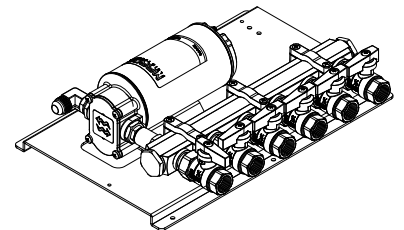

PORTATA FLOW RATE max.	PRESSIONE PRESSURE max.
20 l/min 5.3 gpm	2 bar 29 psi

CODICE PART NUMBER	VOLTS	ADESCAM. SELF-PRIM. m	CONS.	MOTORE MOTOR	FUSIBILE FUSE	BOCCHIE PORTS	PESO WEIGHT
164 926 15	12/24	1,5	7A / 3,5A	180W	10A	1/2" BSPP	8 kg

OCS9/E

- 9 valves
- Reversible



12/24V
100-240V

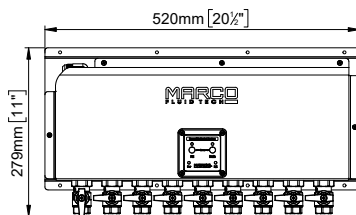

H 279 x L 520 x W 124
H 11" x L 20 1/2" x W 4 7/8"

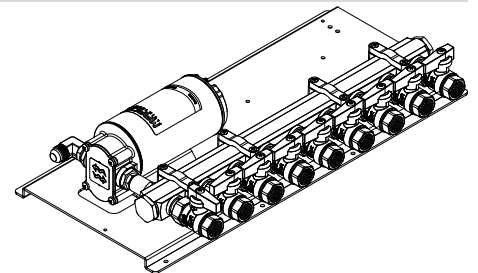

PORTATA FLOW RATE max.	PRESSIONE PRESSURE max.
20 l/min 5.3 gpm	2 bar 29 psi

CODICE PART NUMBER	VOLTS	ADESCAM. SELF-PRIM. m	CONS.	MOTORE MOTOR	FUSIBILE FUSE	BOCCHIE PORTS	PESO WEIGHT
164 928 15	12/24	1,5	7A / 3,5A	180W	10A	1/2" BSPP	10 kg
164 928 1H	100-240	1,5	0,3A	180W	1A	1/2" BSPP	10,8 kg

RCS Reversible Control System

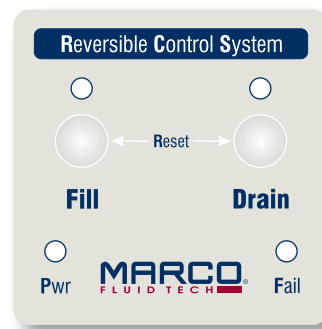

IT Il pannello di controllo RCS, integrato nelle pompe e nei sistemi di travaso e cambio olio, permette di monitorare il funzionamento della pompa ed interagire con essa. Caratteristiche:

- Reversibilità della direzione del flusso che permette due modalità operative: DRAIN per l'aspirazione e FILL per il riempimento.
- Regolazione automatica della velocità del motore in base alla viscosità e alla temperatura del liquido.
- Arresto e riavvio della pompa con la semplice pressione di un tasto.
- Reset istantaneo tramite la pressione simultanea dei due tasti operativi (DRAIN e FILL).
- Arresto automatico dopo 30 secondi in caso di olio troppo viscoso o rubinetto chiuso.
- Arresto automatico dopo 90 secondi dal termine del travaso, quando la pompa è vuota.
- Arresto automatico dopo 30 minuti di funzionamento senza interruzioni (opzione disattivabile direttamente dal pannello).
- Segnalazioni operative tramite LED luminosi.
- Possibilità di impostazione "High Speed" per travaso diesel.

DE Das RCS-Kontrollpaneel, das in den Pumpen und in den Umfüll- und Ölwechselsystemen integriert ist, ermöglicht die Kontrolle der Pumpentätigkeit, sowie eine Interaktion. Eigenschaften:

- Flüssigkeit kann in zwei Richtungen fließen: DRAIN-Modus beim Absaugen und FILL-Modus beim Einfüllen
- automatische Geschwindigkeitsregelung des Motors je nach Zählflüssigkeitsgrad und Temperatur
- Stoppen und Starten der Pumpe wird mit einem Knopfdruck betätigt
- unmittelbares Resetieren erfolgt mit simultanem Drücken der beiden Tasten DRAIN und FILL
- bei allzu zähflüssigem Öl oder bei geschlossenem Hahn erfolgt ein automatischer Stop nach 30 Sekunden
- automatischer Stop nach 90 Sekunden, wenn nach dem Umfüllen die Pumpe leer ist
- automatischer Stop nach 30 Minuten ununterbrochener Arbeit (kann man, wenn unerwünscht, direkt am Panel ausschalten)
- LED-Anzeige bei leerem Behälter
- "High speed" Einstellungsmöglichkeit für Dieselumfüllung

FR Le panneau de contrôle RCS, intégré dans les pompes à huile et les systèmes de changement d'huile vous permet de surveiller à distance le fonctionnement de la pompe et d'interagir avec elle. Caractéristiques:

- Réversibilité du sens d'écoulement, ce qui permet deux modes de fonctionnement : DRAIN pour l'aspiration et FILL pour le remplissage.
- Régulation automatique de la vitesse du moteur en fonction de la viscosité et de la température du liquide.
- Arrêt et démarrage de la pompe avec une simple pression sur un bouton.
- Réinitialisation immédiate en appuyant sur les boutons DRAIN et FILL à la fois.
- Arrêt automatique au bout de 30 secondes en présence d'huile avec une viscosité excessive ou robinet fermé.
- Arrêt automatique au bout de 90 secondes de la fin de l'opération lorsque la pompe est vide.
- Arrêt automatique au bout de 30 minutes de fonctionnement continu (cette option peut être désactivée directement depuis le panneau).
- Les opérations sont signalées par des LEDs lumineuses.
- Possibilité de réglage "High Speed" pour le transvasement de diesel.

EN The RCS control panel integrated in the oil pumps and oil change systems allows you to remotely monitor the operation of the pump and interact with it. Features:

- The reversibility of flow direction allows for two operative modes: DRAIN for aspiration and FILL for filling.
- Automatic regulation of the motor speed according to viscosity and temperature of the liquid.
- Stop and Start of the pump with a simple push of a button.
- Immediate reset by pressing the DRAIN and FILL buttons at the same time.
- Automatic stop after 30 seconds in presence of oil with excessive viscosity or closed tap.
- Automatic stop after 90 seconds from the end of the operation when the pump is empty.
- Automatic stop after 30 minutes of continuous operation (this option can be deactivated directly from the panel).
- Operations are signaled by luminous LEDs.
- Possibility of "High Speed" setting for diesel transfer.

ES El panel de control RCS integrado en las bombas de aceite y en los sistemas de cambio de aceite permite controlar a distancia el funcionamiento de la bomba e interactuar con ella. Características:

- Reversibilidad de la dirección del flujo a través de dos modos operativos: DRAIN para aspiración y FILL para llenado.
- Regulación automática de la velocidad del motor de acuerdo con la viscosidad y la temperatura del líquido.
- Apagamiento e reinicio de la bomba con una simple pulsación de un botón.
- Reajuste inmediato pulsando los botones DRAIN y FILL al mismo tiempo.
- Parada automática después de 30 segundos en presencia de aceite con una viscosidad excesiva o grifo cerrado.
- Parada automática después de 90 segundos desde el final de la operación cuando la bomba está vacía.
- Parada automática después de 30 minutos de funcionamiento continuo (esta opción se puede desactivar directamente desde el panel).
- Las operaciones se indican mediante LEDs luminosos.
- Posibilidad de ajuste al modo "High Speed" para transvase de diésel.

PT O painel de controle RCS integrado nas bombas de óleo e nos sistemas de mudança de óleo permite monitorar remotamente o funcionamento da bomba e interagir com a mesma. Características:

- Dois modos operativos: DRAIN para aspiração e FILL para enchimento, com possibilidade de inversão do sentido de fluxo.
- Regulação automática da velocidade do motor conforme a viscosidade e a temperatura do líquido.
- Paragem e arranque da bomba com uma simples pressão dum botão.
- Redefinição imediata pressionando os botões DRAIN e FILL ao mesmo tempo.
- Paragem automática depois de 30 segundos em presença de óleo com viscosidade excessiva ou torneira fechada.
- Paragem automática depois de 90 segundos a partir do final da operação, quando a bomba está vazia.
- Paragem automática depois de 30 minutos de operação contínua (esta opção pode ser desativada diretamente no painel).
- As operações são sinalizadas por LEDs luminosos.
- Possibilidade de definir o modo "High Speed" para trasfega de diesel.

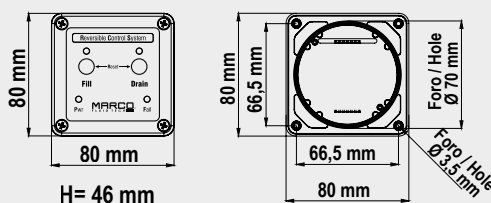

TIPO TYPE	CODICE PART NUMBER	VOLT	DESCRIZIONE DESCRIPTION	PROTEZIONE PROTECTION	DIMENSIONI DIMENSIONS mm	FORO HOLE mm
RCS	165 201 15	12/24	for UP3-RK	IP67	80 x 80 x 46	Ø 70
	165 202 15	12/24	for UP6-RK	IP67	80 x 80 x 46	Ø 70

ELECTRONIC PRESSURE SENSOR

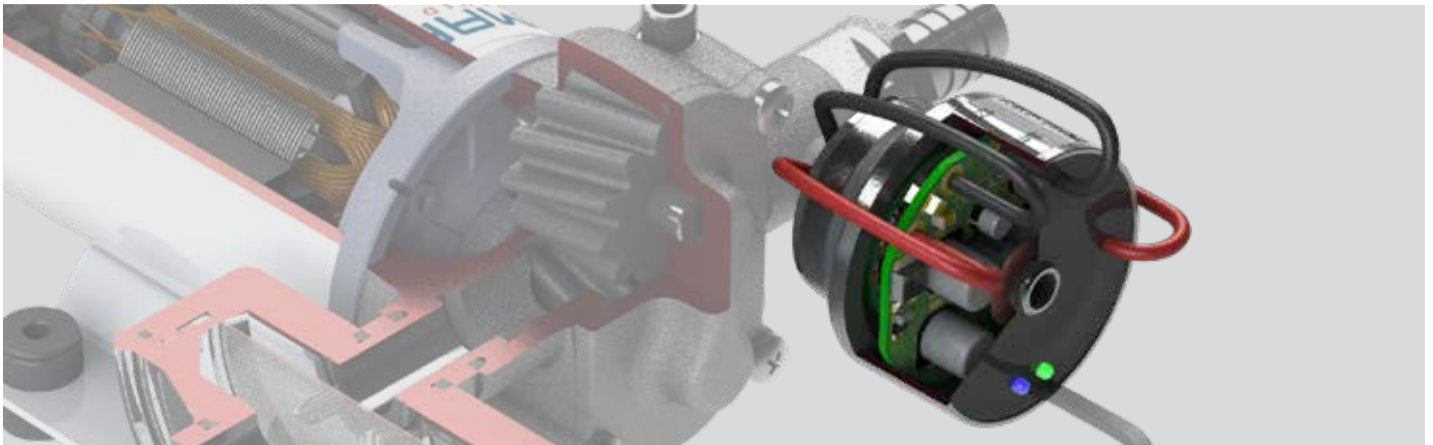

- IT** Il sensore di pressione elettronico regola la portata richiesta variando proporzionalmente i giri del motore e garantisce:
- Controllo costante di pressione, corrente e voltaggio
 - Protezione della pompa da cortocircuiti e sovratensioni
 - Arresto automatico in caso di fine liquido
 - Riduzione dei disturbi elettrici grazie all'accelerazione graduale del motore
 - Maggiore silenziosità
 - Ottimizzazione dei consumi di corrente
 - Minor usura dei componenti e maggior durata del sistema
 - Segnalazioni operative tramite LED luminosi

- EN** The electronic pressure sensor controls the requested flow rate by proportionally adapting the speed of the motor and guarantees:
- Constant control of pressure, voltage and electrical draw
 - Protection of the pump from short circuits and overvoltage
 - Automatic stop in case of no liquid
 - Reduction of electrical interferences thanks to the gradual acceleration of the motor
 - Noise reduction during operation
 - Optimization of electrical draw
 - Reduced wear of components and increased life of the system
 - Operative functions signaled by luminous LEDs

- DE** Der elektronische Drucksensor regelt die angeforderte Durchflussrate, indem er die Motordrehzahl anpasst und garantiert außerdem:
- Konstante Kontrolle von Druck, Strom und Spannung
 - Sichert die Pumpe gegen Kurzschlüssen und Überströmen
 - Automatische Stop-Funktion bei Flüssigkeitsmangel
 - Verminderung der elektrischen Störungen dank der graduellen Steigerung des Motors
 - Geräuschärmer
 - Optimierung des Stromverbrauchs
 - Reduzierung der mechanischen Verschleißteile und verlängerte Dauer des Systems
 - Betriebsfunktionen werden anhand von LED-Leuchten angezeigt

- FR** Le capteur de pression électronique contrôle le débit demandé en adaptant proportionnellement la vitesse du moteur et garantit:
- Contrôle constant de pression, tension et tirage électrique
 - Protection de la pompe contre les courts circuits et les surcharges
 - Arrêt automatique en cas de fin du liquide
 - Réduction des interférences électriques grâce à l'accélération progressive du moteur
 - Réduction du bruit pendant le fonctionnement
 - Optimisation du tirage électrique
 - Réduction de l'usure des composants et durée de vie accrue du système
 - Fonctions opérationnelles signalées par LEDs lumineuses

- ES** El sensor de presión electrónico controla el caudal requerido adaptando gradualmente la velocidad del motor y garantiza:
- Control constante de presión, corriente y voltaje
 - Protección de la bomba contra cortocircuitos y sobretensiones
 - Paro automático en caso de acabar el líquido
 - Reducción de los disturbios eléctricos gracias a la aceleración gradual del motor
 - Reducción del ruido durante el funcionamiento
 - Optimización del consumo eléctrico
 - Menor desgaste de los componentes y mayor duración de la vida del sistema
 - Condiciones operativas señaladas por LEDs luminosos

- PT** O sensor de pressão eletrónico controla o fluxo desejado adaptando gradualmente a velocidade do motor e garante:
- Controle constante de pressão, corrente e tensão
 - Proteção da bomba contra curtos-circuitos e sobretensões
 - Paragem automática em caso do líquido acabar
 - Redução das interferências elétricas graças à aceleração gradual do motor
 - Redução de ruído durante o funcionamento
 - Otimização do consumo de eletricidade
 - Desgaste reduzido dos componentes e maior duração do sistema
 - Condições de funcionamento indicadas pelos LEDs iluminados

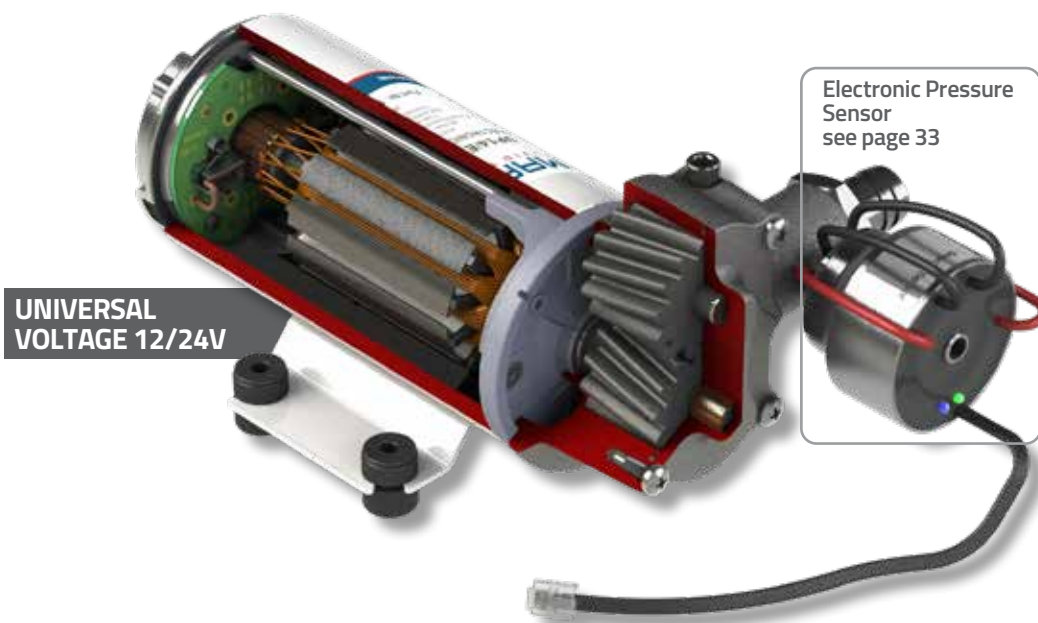

POLYMER GEARS

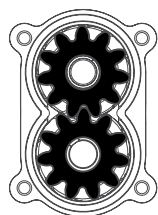

IT Elettropompe autoadescanti ad ingranaggi elicoidali in polimero, voltaggio universale 12V/24V, valvola di non ritorno e sensore di pressione elettronico. Gli ingranaggi in polimero garantiscono pressione costante, cicli di lavoro prolungati, maggiore silenziosità e ottima resistenza ad agenti chimici. Corpo e connessioni in ottone nichelato, albero in acciaio inossidabile, tenute in FKM e O-ring in NBR. Disponibili nella versione con pannello di controllo elettronico per gestione a distanza della pompa.

DE Selbstansaugende, Polymer-Schräg Zahnrad-Elektropumpen, 12V/24V Spannung, mit Rückschlagventil und elektronischem Drucksensor. Die Polymer-Zahnäder garantieren für einen konstanten Druck, für verlängerte Arbeitszyklen, Chemikalienresistenz und für verminderten Geräuschpegel. Gehäuse und Verbindungen aus vernickeltem Messing, Spindel aus rostfreiem Stahl, Dichtungen aus FKM und O-Ring aus NBR. Auch mit elektronischem Kontrollpaneel erhältlich.

FR Pompes électriques auto amorçantes avec engrenages hélicoïdaux en polymère, tension universelle 12V / 24V, clapet anti-retour et capteur de pression électronique. Les engrenages en polymère garantissent une pression constante, long cycles de travail, moins de bruit et une excellente résistance aux produits chimiques. Corps et raccords en laiton nickelé, arbre en acier inoxydable. Joint en FKM et O-Ring en NBR. Disponibles en version avec panneau de contrôle électronique pour la gestion à distance de la pompe.

EN Self-priming electric pumps with helical polymer gears, universal voltage 12V / 24V, check valve and electronic pressure sensor. The polymer gears guarantee constant pressure, heavy-duty cycles, lower noise levels and excellent resistance to chemicals. Body and nickel-plated brass connections, stainless steel shaft. FKM seals and NBR O-rings. Also available with electronic control panel for remote control.

ES Electrobombas eléctricas auto-cebadas con engranajes helicoidales en polímero, voltaje universal 12V/24V, válvula de retención y sensor de presión electrónico. Los engranajes de polímero garantizan una presión constante, largos ciclos de trabajo, niveles de ruido reducidos y una excelente resistencia a los productos químicos. Cuerpo y conexiones en latón niquelado, eje de acero inoxidable. Sellos en FKM y O-ring en NBR. Disponibles en versión con panel de control electrónico para la gestión remota de la bomba.

PT Eletrobombas auto-aspirantes com engrenagens helicoidais em polímero, tensão universal 12V / 24V, válvula de retenção e sensor de pressão eletrônico. As engrenagens de polímero garantem uma pressão constante, longos ciclos de trabalho, baixos níveis de ruído e excelente resistência à produtos químicos. Corpo e ligações em latão niquelado, eixo em aço inox, selos em FKM e O-ring em NBR. Disponíveis na versão com painel de controle eletrônico para a gestão remota da bomba.

UP2/E

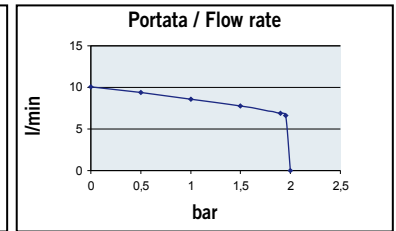
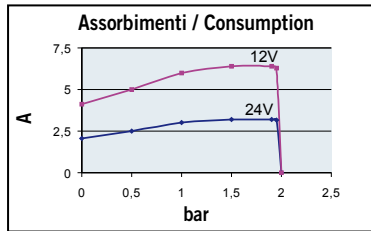
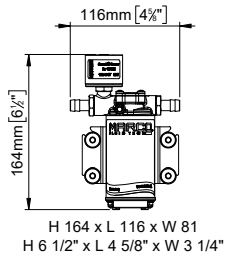

12/24V

PORTATA
FLOW RATE
max.

10 l/min
2.6 gpm

PRESSIONE
PRESSURE
max.

2 bar
29 psi

CODICE
PART NUMBER

164 660 15

VOLTS

12/24

ADESCAM.
SELF-PRIM.
m

1,5

CONS.

3A / 1,5A

MOTORE
MOTOR

90W

FUSIBILE
FUSE

7,5A

TUBO
TUBE

12 mm

BOCCHIE
PORTS

3/8" BSPP

PESO
WEIGHT

1,3 kg

UP3/E



OPTIONAL

PCS Control Panel (page 40)

PEEK
GEARS

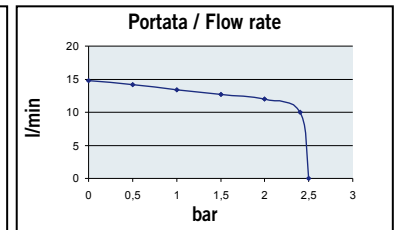
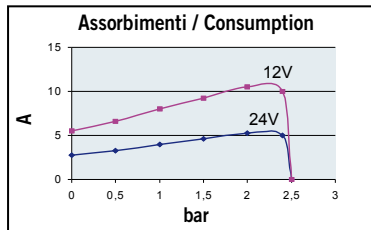
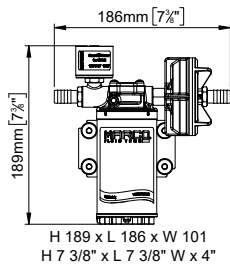

12/24V

PORTATA
FLOW RATE
max.

15 l/min
4 gpm

PRESSIONE
PRESSURE
max.

2,5 bar
36 psi

CODICE
PART NUMBER

164 602 15

VOLTS

12/24

ADESCAM.
SELF-PRIM.
m

1,5

CONS.

6A / 3A

MOTORE
MOTOR

150W

FUSIBILE
FUSE

15A

TUBO
TUBE

13 mm

BOCCHIE
PORTS

3/8" BSPP

PESO
WEIGHT

2 kg

UP6/E



OPTIONAL

PCS Control Panel (page 40)

PEEK
GEARS

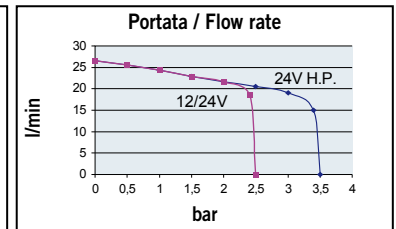
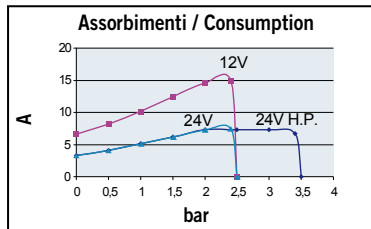
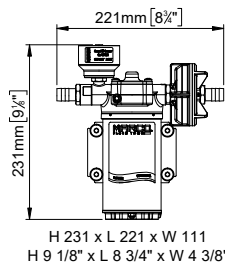

12/24V

PORTATA
FLOW RATE
max.

26 l/min
6.9 gpm

PRESSIONE
PRESSURE
max.

2,5 bar
36 psi

CODICE
PART NUMBER

164 622 15

VOLTS

12/24

ADESCAM.
SELF-PRIM.
m

1,5

CONS.

10A / 5A

MOTORE
MOTOR

180W

FUSIBILE
FUSE

20A

TUBO
TUBE

16 mm

BOCCHIE
PORTS

1/2" BSPP

PESO
WEIGHT

3,7 kg

HIGH
PRESSURE

3,5 bar
50.8 psi

164 622 13

24

1,5

5A

180W

10A

16 mm

1/2" BSPP

3,7 kg

WATER AND FLUID TRANSFER PUMPS

UP12/E



12/24V



OPTIONAL

PCS Control Panel (page 40)

PEEK GEARS

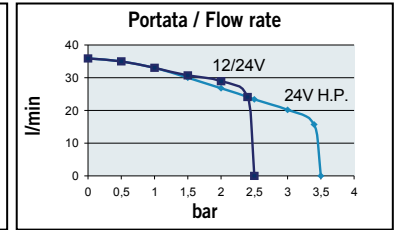
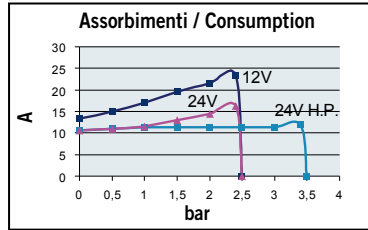
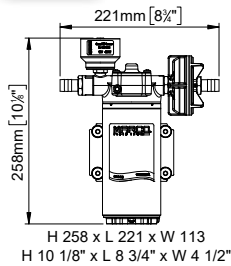

PORTATA FLOW RATE max.	PRESSIONE PRESSURE max.
36 l/min 9.5 gpm	2,5 bar 36 psi
HIGH PRESSURE	3,5 bar 50.8 psi

CODICE PART NUMBER	VOLTS	ADESCAM. SELF-PRIM. m	CONS.	MOTORE MOTOR	FUSIBILE FUSE	TUBO TUBE	BOCCHIE PORTS	PESO WEIGHT
164 681 15	12/24	3	14A / 7A	360W	25A	16 mm	1/2" BSPP	4,9 kg
164 681 13	24	3	7A	360W	15A	16 mm	1/2" BSPP	4,9 kg

UP12/E-LO



12/24V



OPTIONAL

PCS Control Panel (page 40)

PEEK GEARS

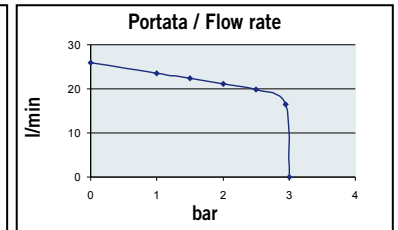
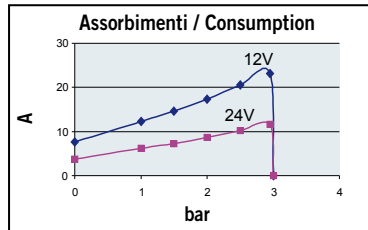
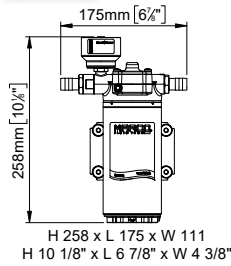

PORTATA FLOW RATE max.	PRESSIONE PRESSURE max.
26 l/min 6.9 gpm	3 bar 43.5 psi

CODICE PART NUMBER	VOLTS	ADESCAM. SELF-PRIM. m	CONS.	MOTORE MOTOR	FUSIBILE FUSE	TUBO TUBE	BOCCHIE PORTS	PESO WEIGHT
164 687 15	12/24	3	14A / 7A	360W	25A	16 mm	1/2" BSPP	4,9 kg

UP14/E



12/24V



INCLUDED

PCS Control Panel (page 40)

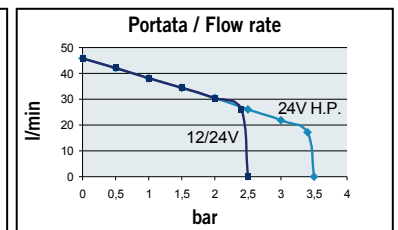
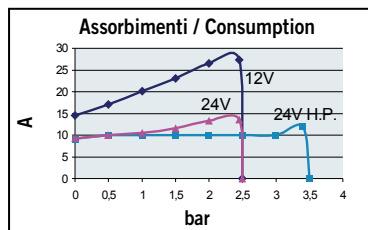
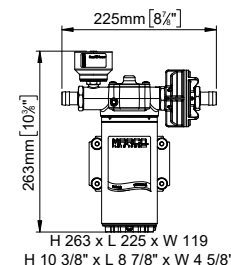

PORTATA FLOW RATE max.	PRESSIONE PRESSURE max.
46 l/min 12.2 gpm	2,5 bar 36 psi
HIGH PRESSURE	3,5 bar 50.8 psi

CODICE PART NUMBER	VOLTS	ADESCAM. SELF-PRIM. m	CONS.	MOTORE MOTOR	FUSIBILE FUSE	TUBO TUBE	BOCCHIE PORTS	PESO WEIGHT
164 690 15	12/24	3	18A / 9A	400W	30A	19 mm	3/4" BSPP	5,2 kg
164 690 13	24	3	9A	400W	15A	19 mm	3/4" BSPP	5,2 kg

UP6/E-DX



INCLUDED

PCS Control Panel (page 40)

PEEK GEARS

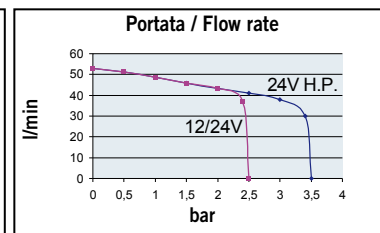
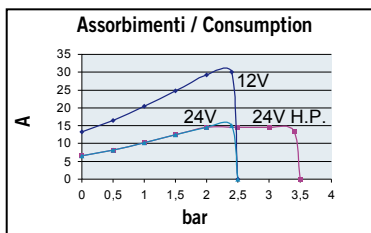
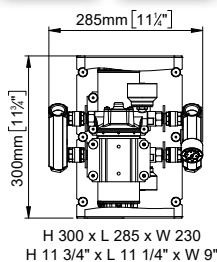

12/24V

PORTATA
FLOW RATE
max.

52 l/min
13.7 gpm

PRESSIONE
PRESSURE
max.

2,5 bar
36 psi

HIGH
PRESSURE

3,5 bar
50.8 psi

CODICE PART NUMBER	VOLTS	ADESCAM. SELF-PRIM. m	CONS.	MOTORE MOTOR	FUSIBILE FUZE	BOCCHIE PORTS	PESO WEIGHT
164 624 15	12/24	1,5	16A / 8A	2 x 180W	40A	3/4" BSPP	11 kg
164 624 13	24	1,5	8A	2 x 180W	20A	3/4" BSPP	11 kg

UP66/E-DX



INCLUDED

PCS Control Panel (page 40)

PEEK GEARS

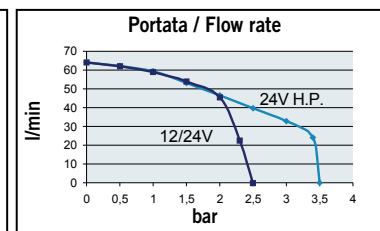
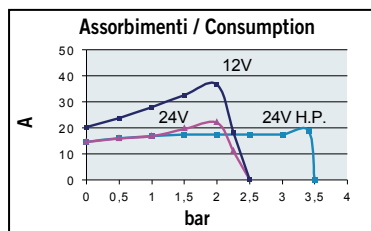
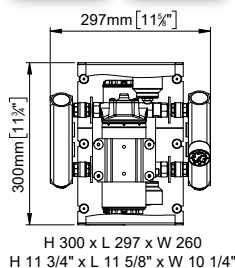

12/24V

PORTATA
FLOW RATE
max.

66 l/min
17.4 gpm

PRESSIONE
PRESSURE
max.

2,5 bar
36.3 psi

HIGH
PRESSURE

3,5 bar
50.8 psi

CODICE PART NUMBER	VOLTS	ADESCAM. SELF-PRIM. m	CONS.	MOTORE MOTOR	FUSIBILE FUZE	BOCCHIE PORTS	PESO WEIGHT
164 627 15	12/24	2	20A / 15A	1 x 180W 1 x 360W	50A	3/4" BSPP	13 kg
164 627 13	24	2	15A	1 x 180W 1 x 360W	25A	3/4" BSPP	13 kg

UP12/E-DX



INCLUDED

PCS Control Panel (page 40)

PEEK GEARS

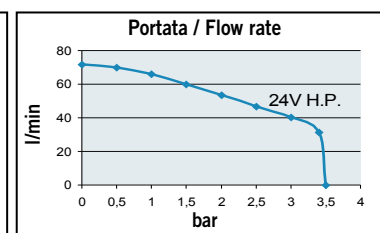
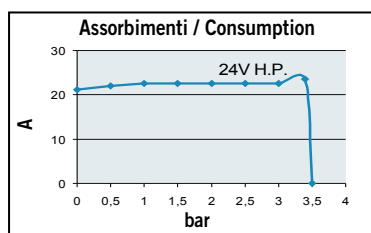
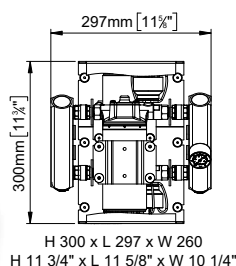

24V

PORTATA
FLOW RATE
max.

72 l/min
19 gpm

PRESSIONE
PRESSURE
max.

3,5 bar
50.8 psi

HIGH PRESSURE

CODICE PART NUMBER	VOLTS	ADESCAM. SELF-PRIM. m	CONS.	MOTORE MOTOR	FUSIBILE FUZE	BOCCHIE PORTS	PESO WEIGHT
164 686 13	24	3	20A	2 x 360W	30A	1" BSPP	15 kg

WATER AND FLUID TRANSFER PUMPS

UP14/E-DX



DUAL PUMPS

24V



INCLUDED

PCS Control Panel (page 40)

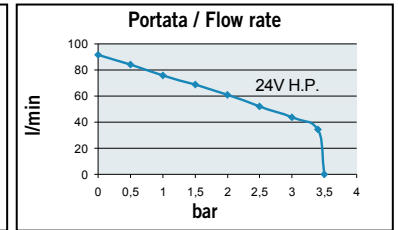
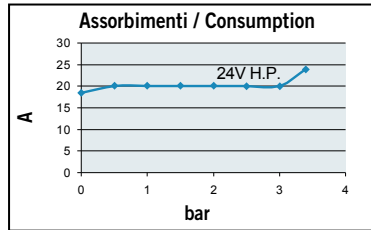
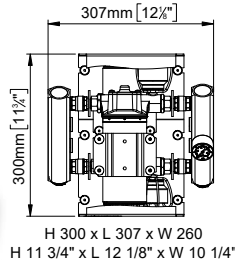

PORTATA
FLOW RATE
max.

92 l/min
24.3 gpm

PRESSIONE
PRESSURE
max.

3,5 bar
50.8 psi

HIGH PRESSURE

CODICE PART NUMBER	VOLT	ADESCAM. SELF-PRIM. m	CONS.	MOTORE MOTOR	FUSIBILE FUZE	BOCCHIE PORTS	PESO WEIGHT
164 691 13	24	3	18A	2 x 400W	30A	1" BSPP	17 kg

UP8/E



12/24V



OPTIONAL

PCS Control Panel (page 40)

PEEK
GEARS

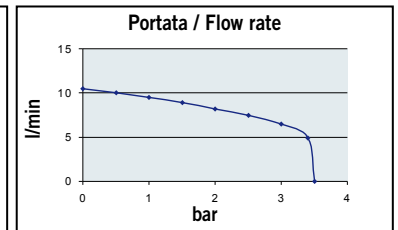
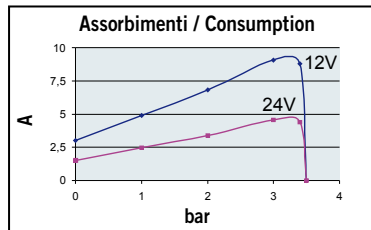
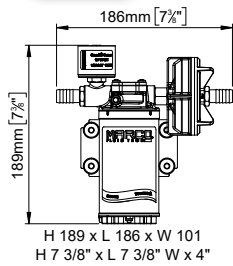

PORTATA
FLOW RATE
max.

10 l/min
2.6 gpm

PRESSIONE
PRESSURE
max.

3,5 bar
50.8 psi

HIGH PRESSURE

CODICE PART NUMBER	VOLTS	ADESCAM. SELF-PRIM. m	CONS.	MOTORE MOTOR	FUSIBILE FUZE	TUBO TUBE	BOCCHIE PORTS	PESO WEIGHT
164 635 15	12/24	1,5	4A / 2A	150W	15A	13 mm	3/8" BSPP	2,1 kg

UP9/E



12/24V



OPTIONAL

PCS Control Panel (page 40)

PEEK
GEARS

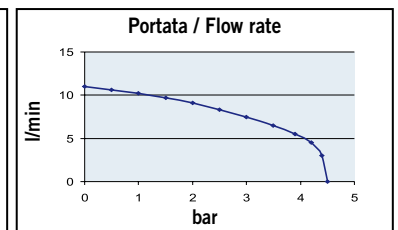
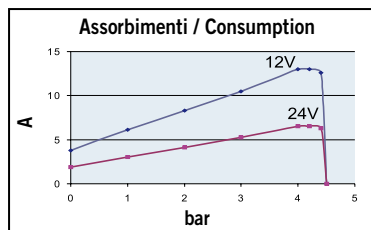
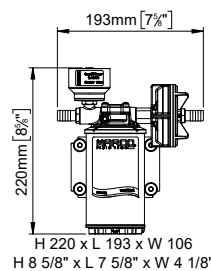

PORTATA
FLOW RATE
max.

12 l/min
3.2 gpm

PRESSIONE
PRESSURE
max.

4,5 bar
65.3 psi

HIGH PRESSURE

CODICE PART NUMBER	VOLTS	ADESCAM. SELF-PRIM. m	CONS.	MOTORE MOTOR	FUSIBILE FUZE	TUBO TUBE	BOCCHIE PORTS	PESO WEIGHT
164 642 15	12/24	1,5	5A / 2,5A	180W	15A	13 mm	3/8" BSPP	3,3 kg

UP10/E



12/24V



OPTIONAL

PCS Control Panel (page 40)

PEEK
GEARS

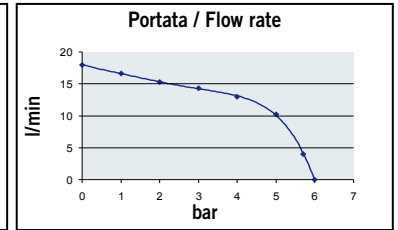
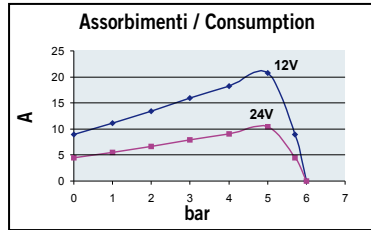
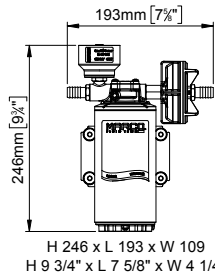

PORTATA
FLOW RATE
max.

18 l/min
4.8 gpm

PRESSIONE
PRESSURE
max.

6 bar
87 psi

HIGH PRESSURE

CODICE PART NUMBER	VOLTS	ADESCAM. SELF-PRIM. m	CONS.	MOTORE MOTOR	FUSIBILE FUSE	TUBO TUBE	BOCCHIE PORTS	PESO WEIGHT
164 404 15	12/24	3	11A / 5,5A	360W	25A	13 mm	3/8" BSPP	4,3 kg

PCS Pump Control System

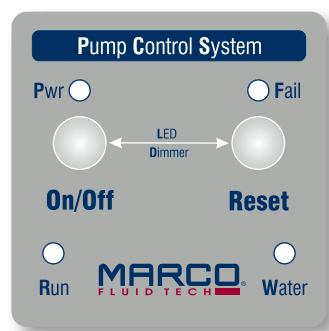

IT Il pannello di controllo PCS permette di monitorare a distanza il funzionamento della pompa ed interagire con essa.

Caratteristiche:

- Monitoraggio a distanza del funzionamento della pompa ed interazione con essa: verifica della presenza di liquido e reset in caso di malfunzionamento senza togliere l'alimentazione.
- Il LED "Run" segnala il funzionamento della pompa ed avvisa in caso di piccole perdite nell'impianto evitando danni al motore a causa del funzionamento prolungato a bassi giri.
- Arresto e riavvio della pompa con la semplice pressione di un tasto.
- Connessione rapida del pannello al cavo di 3m con attacco RJ11/6 integrato nel sensore della pompa.
- Possibilità di montaggio ad incasso con foro circolare di diametro 70mm o di montaggio esterno.
- Morsetteria che permette di replicare i pulsanti e i LED presenti sul pannello su un circuito esterno: questo permette di gestire in modo personalizzato le funzionalità su un dispositivo progettato da terze parti.

DE Das PCS Kontroll-Panel ermöglicht es, die elektronische Pumpe fern zu steuern und mit ihr zu interagieren.

Eigenschaften:

- Fernüberwachung des Pumpenlaufs und deren Fernsteuerung: kontrolliert das Vorhandensein von Flüssigkeit, bei Fehlbetrieb schaltet sich die Reset-Funktion ein, ohne alles ausschalten zu müssen.
- Das "Run" LED zeigt an, dass die Pumpe arbeitet und gibt eine Warnung an bei kleinen Wasserverlusten im System. Damit kann, bei längerem Betrieb mit niedrigen Umdrehungen, ein Motorschaden verhindert werden.
- Stoppen und Starten der Pumpe wird mit einem Knopfdruck betätigt.
- Schnellverbindung des Paneels an das 3m RJ11/6 Kabel, das in dem Pumpensensor integriert ist.
- Einbaumöglichkeit in rundem, 70mm- Durchmesser Loch oder externe Montage.
- Mit dem Verteiler kann man die Knöpfe und LEDs des Paneels auf einen externen Kreis wiedergeben: dieses ermöglicht eine individuelle Einstellung der Funktionen auf einer externen Vorrichtung, die von Dritten entworfen wurde.

FR Le panneau de contrôle PCS vous permet de surveiller à distance le fonctionnement de la pompe et d'interagir avec elle.

Les caractéristiques:

- Surveillance à distance du fonctionnement de la pompe et de l'interaction avec elle: vérification de la présence de liquide et réinitialisation en cas de dysfonctionnement sans débrancher l'appareil.
- Le LED "Run" indique que la pompe est en marche et donne l'alerte en cas de petites fuites dans le système, pour prévenir des dommages au moteur en raison d'un fonctionnement prolongé à faible vitesse.
- Arrêt et démarrage de la pompe avec une simple pression sur un bouton.
- Connexion rapide du panneau au câble de 3m avec terminal RJ11/6, intégré dans le capteur de la pompe.
- Le panneau peut être encastré dans un trou circulaire d'un diamètre de 70 mm ou monté à l'extérieur.
- Le bornier permet à l'utilisateur de reproduire les boutons et les LEDs du panneau sur un circuit externe favorisant ainsi une gestion personnalisée des fonctions grâce à un dispositif externe conçu par des tiers.

EN The PCS control panel allows you to remotely monitor the operation of the pump and interact with it.

Characteristics:

- Remote monitoring of the pump operation and interaction with it: checking of liquid presence and reset in case of malfunction without disconnecting the device.
- The "Run" LED indicates that the pump is working and alerts in case of small leaks in the system, preventing motor damage due to prolonged operation at low speed.
- Stop and Start of the pump with a simple push of a button.
- Quick connection of the panel to the 3m RJ11/6 terminal cable integrated in the sensor of the pump.
- The panel can be recessed in a circular hole of a 70mm diameter or externally mounted.
- The terminal block allows the user to replicate the buttons and leds of the panel on an external circuit thus favoring a personalized management of the functions through an external device designed by third parties.

ES El panel de control PCS permite controlar a distancia el funcionamiento de la bomba e interactuar con ella.

Características:

- Monitorización remota del funcionamiento de la bomba e interacción con ella: comprobación de la presencia de líquido y reinicio en caso de avería sin necesidad de desconectar el dispositivo.
- El LED « Run » indica que de la bomba está funcionando y avisa en caso de pequeñas fugas en el sistema, para prevenir daños en el motor debido al funcionamiento prolongado a baja velocidad.
- Apagamiento e reinicio de la bomba con una simple pulsación de un botón.
- Conexión rápida del panel al cable de 3m con terminal RJ11 / 6, integrado en el sensor de la bomba.
- El panel puede ser empotrado dentro de un orificio circular de un diámetro de 70 mm o montado externamente.
- El bloque de terminales permite al usuario reproducir los botones y LEDs del panel en un circuito externo: esto permite una gestión personalizada de las funciones a través de un dispositivo externo diseñado por terceros.

PT O painel de controle PCS permite monitorar remotamente o funcionamento da bomba e interagir com a mesma.

Características:

- Monitoramento remoto da operação da bomba e interação com a mesma: verificação da presença de líquido e reinício em caso de funcionamento defeituoso sem desligar o dispositivo.
- O LED "Run" indica que a bomba está funcionando e alerta em caso de pequenas fugas no sistema, para evitar danos no motor devido a um funcionamento prolongado a baixa velocidade.
- Paragem e arranque da bomba com uma simples pressão dum botão.
- Ligação rápida do painel ao cabo de 3m com terminal RJ11 / 6, integrado no sensor da bomba.
- O painel pode ser embutido num orifício circular com um diâmetro de 70 mm ou montado externamente.
- Um bloco de terminais permite replicar os botões e LEDs do painel num circuito externo: isto permite controlar individualmente as funções num dispositivo projetado por terceiros.

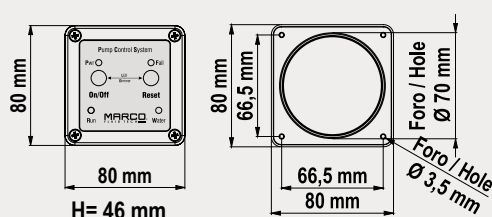

TIPO TYPE	CODICE PART NUMBER	VOLT	PROTEZIONE PROTECTION	DIMENSIONI DIMENSIONS mm	FORO HOLE mm	CONNESSIONE CONNECTION
PCS	165 203 15	12/24	IP65	80 x 80 x 46	Ø 70	RJ11

Electronic Pressure Pump Kits

12V and 24V - DC

DP3/E

▪ Wash down kit with 15m/50ft retractable hose

PEEK
GEARS



12/24V

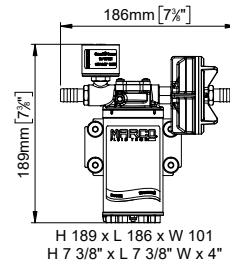

DQC Connection
see page 67



PORTATA
FLOW RATE
max.

PRESSIONE
PRESSURE
max.

14 l/min
3.7 gpm

3 bar
43.5 psi

CODICE
PART NUMBER

VOLTS

ADESCAM.
SELF-PRIM.
m

CONS.

MOTORE
MOTOR

FUSIBILE
FUZE

TUBO
TUBE

BOCCHE
PORTS

PESO
WEIGHT

164 801 15

12/24

1,5

10A

150W

15A

13 mm

3/8" BSPP

4,6 kg

DP9/E

▪ Wash down kit with 15m/50ft retractable hose

PEEK
GEARS



12/24V

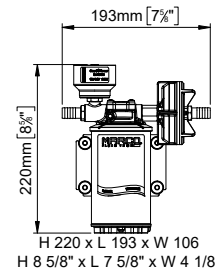

DQC Connection
see page 67



PORTATA
FLOW RATE
max.

PRESSIONE
PRESSURE
max.

12 l/min
3.2 gpm

4,5 bar
65.3 psi

HIGH PRESSURE

CODICE
PART NUMBER

VOLTS

ADESCAM.
SELF-PRIM.
m

CONS.

MOTORE
MOTOR

FUSIBILE
FUZE

TUBO
TUBE

BOCCHE
PORTS

PESO
WEIGHT

164 821 15

12/24

1,5

12A

180W

15A

13 mm

3/8" BSPP

4,6 kg

DP12/E

▪ Wash down kit with 15m/50ft retractable hose

PEEK
GEARS

Link to video
page 69



12/24V

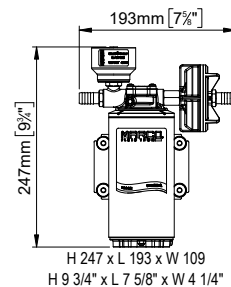

DQC Connection
see page 67



PORTATA
FLOW RATE
max.

PRESSIONE
PRESSURE
max.

15 l/min
4 gpm

6 bar
87 psi

HIGH PRESSURE

CODICE
PART NUMBER

VOLTS

ADESCAM.
SELF-PRIM.
m

CONS.

MOTORE
MOTOR

FUSIBILE
FUZE

TUBO
TUBE

BOCCHE
PORTS

PESO
WEIGHT

164 841 15

12/24

3

24A

360W

25A

13 mm

3/8" BSPP

5,5 kg

WATER AND FLUID TRANSFER PUMPS

SP2

▪ Complete shower kit



12/24V

PORTATA FLOW RATE max.	PRESSIONE PRESSURE max.
10 l/min 2.6 gpm	2 bar 29 psi

CODICE PART NUMBER	VOLTS	ADESCAM. SELF-PRIM. m	CONS.	MOTORE MOTOR	FUSIBILE FUSE	TUBO TUBE	BOCCHE PORTS	PESO WEIGHT
164 900 15	12/24	1,5	3A / 1,5A	90W	7,5A	12 mm	3/8" BSPP	2,3 kg

TK1/2

▪ Tank kit 107 liters

107
LITERS

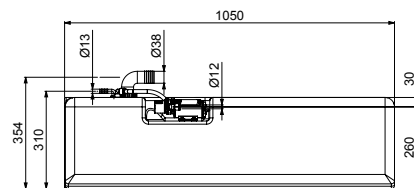
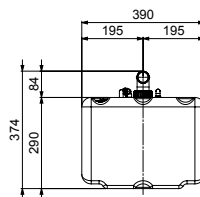
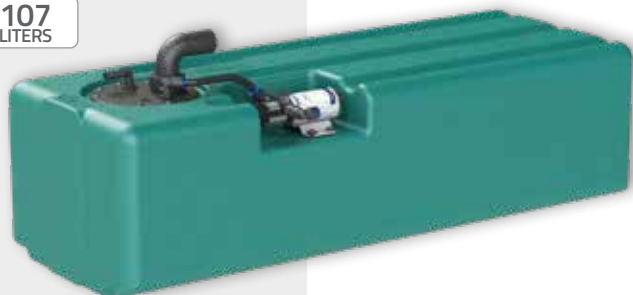

12/24V

PORTATA FLOW RATE max.	PRESSIONE PRESSURE max.
10 l/min 2.6 gpm	2 bar 29 psi

CODICE PART NUMBER	VOLTS	POMPA PUMP	CAPACITA SERBATOIO TANK CAPACITY l	DIMENSIONI DIMENSIONS mm	FUSIBILE FUSE	BOCCHE PORTS
164 910 15	12/24	UP2/E	107	1050 x 290 x 390	7,5A	3/8" BSPP

TK2/2

▪ Tank kit 67 liters

67
LITERS

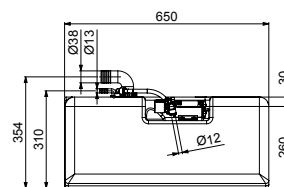
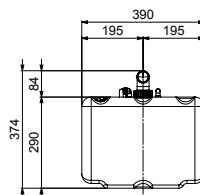

12/24V

PORTATA FLOW RATE max.	PRESSIONE PRESSURE max.
10 l/min 2.6 gpm	2 bar 29 psi

CODICE PART NUMBER	VOLTS	POMPA PUMP	CAPACITA SERBATOIO TANK CAPACITY l	DIMENSIONI DIMENSIONS mm	FUSIBILE FUSE	BOCCHE PORTS
164 911 15	12/24	UP2/E	67	650 x 290 x 390	7,5A	3/8" BSPP

TK1-SP

▪ Tank kit 107 liters

107
LITERS



12/24V

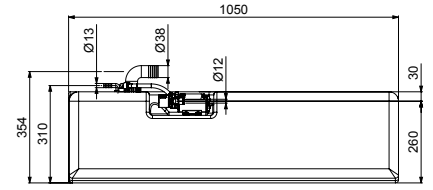
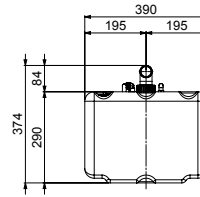

PORTATA FLOW RATE max.	PRESSIONE PRESSURE max.	CODICE PART NUMBER	VOLTS	POMPA PUMP	CAPACITA SERBATOIO TANK CAPACITY l	DIMENSIONI DIMENSIONS mm	FUSIBILE FUSE	BOCCHIE PORTS
10 l/min 2.6 gpm	2 bar 29 psi	164 913 15	12/24	UP2/E	107	1050 x 290 x 390	7,5A	3/8" BSPP

TK2-SP

▪ Tank kit 67 liters

67
LITERS



12/24V

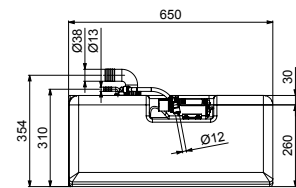
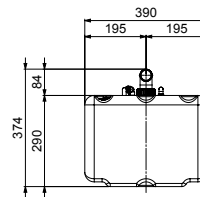

PORTATA FLOW RATE max.	PRESSIONE PRESSURE max.	CODICE PART NUMBER	VOLTS	POMPA PUMP	CAPACITA SERBATOIO TANK CAPACITY l	DIMENSIONI DIMENSIONS mm	FUSIBILE FUSE	BOCCHIE PORTS
10 l/min 2.6 gpm	2 bar 29 psi	164 914 15	12/24	UP2/E	67	650 x 290 x 390	7,5A	3/8" BSPP

TK1-SP3

▪ Tank kit 107 liters

PEEK
GEARS

107
LITERS



12/24V

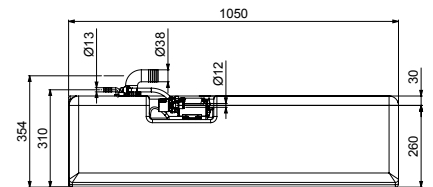
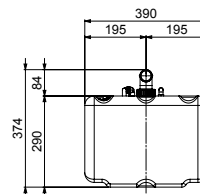

PORTATA FLOW RATE max.	PRESSIONE PRESSURE max.	CODICE PART NUMBER	VOLTS	POMPA PUMP	CAPACITA SERBATOIO TANK CAPACITY l	DIMENSIONI DIMENSIONS mm	FUSIBILE FUSE	BOCCHIE PORTS
15 l/min 4 gpm	2,5 bar 36 psi	164 915 15	12/24	UP3/E	107	1050 x 290 x 390	15A	3/8" BSPP

Polymer Gear Pumps



POLYMER GEARS

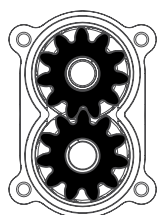

IT Elettropompe autoadescanti ad ingranaggi elicoidali in polimero per travaso acqua e liquidi a bassa viscosità. Gli ingranaggi in polimero garantiscono pressione costante, cicli di lavoro prolungati, maggiore silenziosità e ottima resistenza ad agenti chimici. Corpo in ottone nichelato, albero in acciaio inossidabile e tenuta in FKM se non diversamente specificato. Disponibili in versioni con filtro in linea, valvola di non ritorno, pressostato meccanico, sensore di pressione elettronico e kit per applicazioni varie.

DE Selbstansaugende Elektropumpen mit Polymer-Schrägzahnrädern. Die Polymer-Zahnräder garantieren für einen konstanten Druck, für verlängerte Arbeitszyklen, Chemikalienresistenz und für verminderten Geräuschpegel. Gehäuse aus vernickeltem Messing, Spindel aus rostfreiem Stahl, Dichtung aus FKM, falls nicht anders angegeben. Modelle lieferbar mit In-Line-Filter, Rückschlagventil, mechanischem Druckwächter, elektronischem Drucksensor sowie Montageset für verschiedene Anwendungen.

FR Pompes électriques auto amorçantes avec des engrenages hélicoïdaux de polymère pour le transfert de l'eau et des liquides à faible viscosité. Les engrenages en polymère garantissent une pression constante, long cycles de travail, moins de bruit et une excellente résistance aux produits chimiques. Corps en laiton nickelé, arbre en acier inoxydable et joint en FKM, sauf indication contraire. Disponibles dans les versions avec filtre en ligne, clapet anti-retour, interrupteur de pression mécanique, capteur de pression électronique et des kits pour applications différentes.

EN Self priming electric pumps with helical polymer gears for the transfer of water and liquids with low viscosity. The polymer gears guarantee constant pressure, heavy-duty cycles, lower noise levels and excellent resistance to chemicals. Nickel-plated brass body, stainless steel shaft and FKM seal unless otherwise specified. Available in versions with in-line filter, integrated check valve, mechanical pressure switch, electronic pressure sensor and kits for various applications.

ES Bombas eléctricas auto-cebadas con engranajes helicoidales en polímero para la transferencia de agua y líquidos de baja viscosidad. Los engranajes de polímero garantizan una presión constante, largos ciclos de trabajo, niveles de ruido reducidos y una excelente resistencia a los productos químicos. Cuerpo en latón niquelado, eje de acero inoxidable y junta de FKM si no diferentemente especificado. Disponible en versiones con filtro en línea, válvula de retención, interruptor de presión mecánico, sensor de presión electrónico y kits para diversas aplicaciones.

PT Bombas com engrenagens helicoidais em polímero para a transferência de água e líquidos de baixa viscosidade. As engrenagens de polímero garantem uma pressão constante, longos ciclos de trabalho, baixos níveis de ruído e excelente resistência aos produtos químicos. Corpo em latão niquelado, eixo em aço inox e junta em FKM salvo indicação diferente. Disponíveis em versões com filtro em linha, válvula anti-retorno, interruptor de pressão mecânico, sensor de pressão eletrônico e kits para várias aplicações.

Polymer Gears 12V and 24V - DC

UP2-P



12V
24V

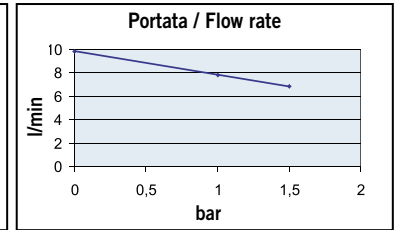
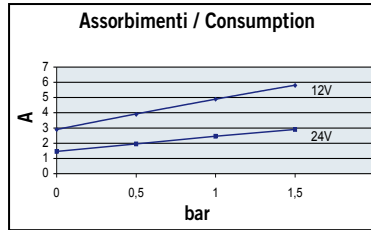
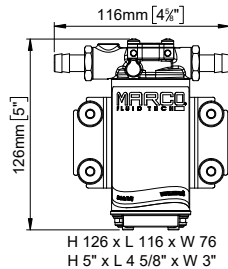

PORTATA FLOW RATE max.	PRESSIONE PRESSURE max.
10 l/min 2.6 gpm	1,5 bar 22 psi

CODICE PART NUMBER	VOLTS	ADESCAM. SELF-PRIM. m	CONS.	MOTORE MOTOR	FUSIBILE FUSE	TUBO TUBE	BOCCHIE PORTS	PESO WEIGHT
164 202 12	12	1,5	3A	90W	5A	12 mm	3/8" BSPP	1,2 kg
164 202 13	24	1,5	1,5A	90W	3A	12 mm	3/8" BSPP	1,2 kg

UP2-PV

Integrated check valve



12V
24V

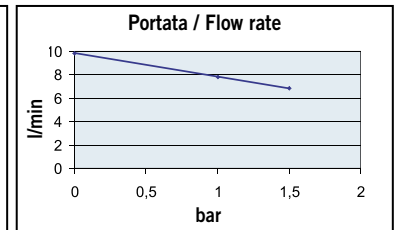
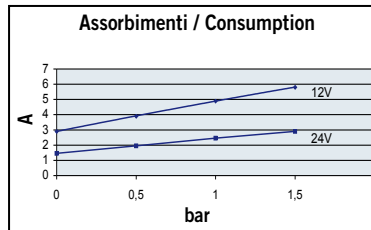
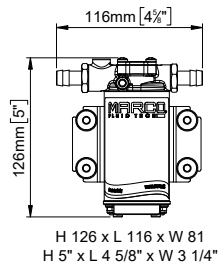

PORTATA FLOW RATE max.	PRESSIONE PRESSURE max.
10 l/min 2.6 gpm	1,5 bar 22 psi

CODICE PART NUMBER	VOLTS	ADESCAM. SELF-PRIM. m	CONS.	MOTORE MOTOR	FUSIBILE FUSE	TUBO TUBE	BOCCHIE PORTS	PESO WEIGHT
164 204 12	12	1,5	3A	90W	5A	12 mm	3/8" BSPP	1,2 kg
164 204 13	24	1,5	1,5A	90W	3A	12 mm	3/8" BSPP	1,2 kg

UP3-P

PEEK
GEARS



12V
24V

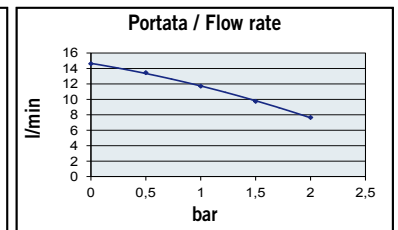
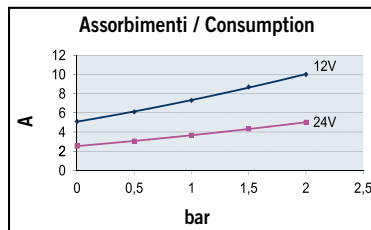
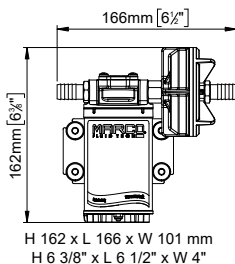

PORTATA FLOW RATE max.	PRESSIONE PRESSURE max.
15 l/min 4 gpm	2 bar 29 psi

CODICE PART NUMBER	VOLTS	ADESCAM. SELF-PRIM. m	CONS.	MOTORE MOTOR	FUSIBILE FUSE	TUBO TUBE	BOCCHIE PORTS	PESO WEIGHT
164 002 12	12	1,5	6A	120W	10A	13 mm	3/8" BSPP	1,6 kg
164 002 13	24	1,5	3A	120W	5A	13 mm	3/8" BSPP	1,6 kg

WATER AND FLUID TRANSFER PUMPS

UP3-PV

▪ Integrated check valve

PEEK
GEARS



12V
24V

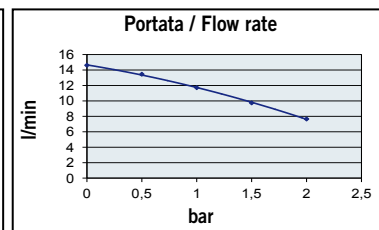
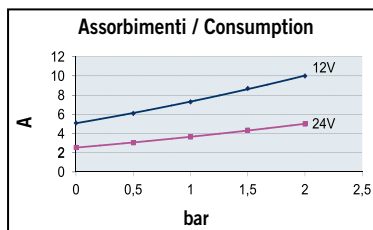
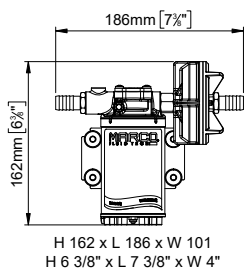

PORTATA
FLOW RATE
max.
15 l/min
4 gpm

PRESSIONE
PRESSURE
max.
2 bar
29 psi

CODICE PART NUMBER	VOLTS	ADESCAM. SELF-PRIM. m	CONS.	MOTORE MOTOR	FUSIBILE FUSE	TUBO TUBE	BOCCHIE PORTS	PESO WEIGHT
164 004 12	12	1,5	6A	120W	10A	13 mm	3/8" BSPP	1,6 kg
164 004 13	24	1,5	3A	120W	5A	13 mm	3/8" BSPP	1,6 kg

UPX

▪ Stainless steel AISI 316L ▪ Silicone O-rings

PEEK
GEARS



12V
24V

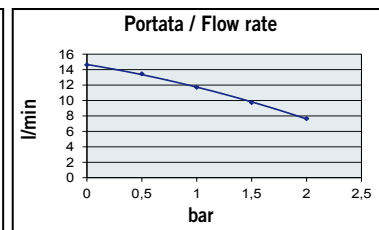
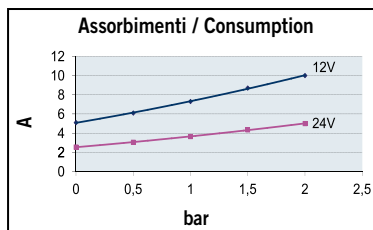
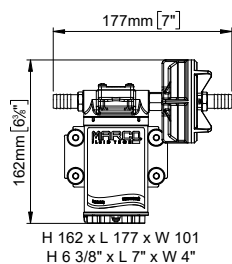

PORTATA
FLOW RATE
max.
15 l/min
4 gpm

PRESSIONE
PRESSURE
max.
2 bar
29 psi

CODICE PART NUMBER	VOLTS	ADESCAM. SELF-PRIM. m	CONS.	MOTORE MOTOR	FUSIBILE FUSE	TUBO TUBE	BOCCHIE PORTS	PESO WEIGHT
164 040 12	12	1,5	6A	120W	10A	13 mm	3/8" BSPP	1,4 kg
164 040 13	24	1,5	3A	120W	5A	13 mm	3/8" BSPP	1,4 kg

UPX-C

▪ Stainless steel AISI 316L

PEEK
GEARS



12V
24V

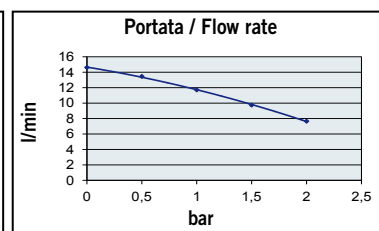
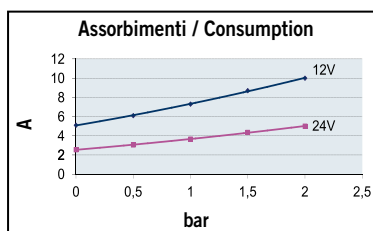
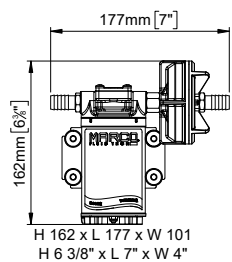

PORTATA
FLOW RATE
max.
15 l/min
4 gpm

PRESSIONE
PRESSURE
max.
2 bar
29 psi

CODICE PART NUMBER	VOLTS	ADESCAM. SELF-PRIM. m	CONS.	MOTORE MOTOR	FUSIBILE FUSE	TUBO TUBE	BOCCHIE PORTS	PESO WEIGHT
164 041 12	12	1,5	6A	120W	10A	13 mm	3/8" BSPP	1,4 kg
164 041 13	24	1,5	3A	120W	5A	13 mm	3/8" BSPP	1,4 kg

UP6-P

PEEK
GEARS



12V
24V

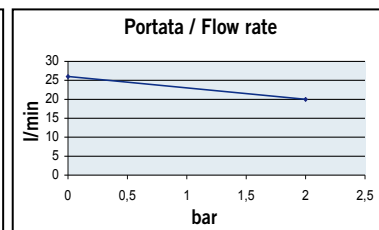
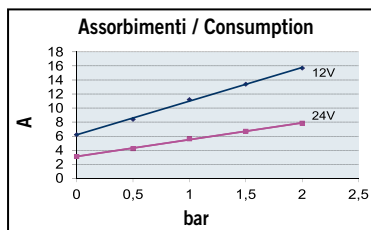
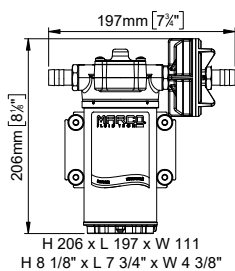

PORTATA
FLOW RATE
max.

PRESSIONE
PRESSURE
max.

26 l/min
6.9 gpm

2 bar
29 psi

CODICE PART NUMBER	VOLTS	ADESCAM. SELF-PRIM. m	CONS.	MOTORE MOTOR	FUSIBILE FUSE	TUBO TUBE	BOCCHIE PORTS	PESO WEIGHT
164 065 12	12	1,5	10A	180W	15A	16 mm	1/2" BSPP	3,1 kg
164 065 13	24	1,5	5A	180W	7,5A	16 mm	1/2" BSPP	3,1 kg

UP6-PV

Integrated check valve

PEEK
GEARS



12V
24V

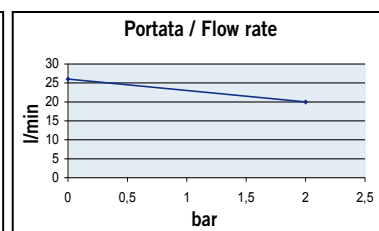
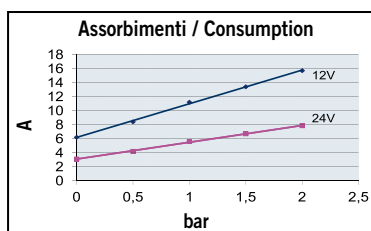
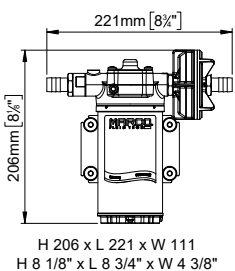

PORTATA
FLOW RATE
max.

PRESSIONE
PRESSURE
max.

26 l/min
6.9 gpm

2 bar
29 psi

CODICE PART NUMBER	VOLTS	ADESCAM. SELF-PRIM. m	CONS.	MOTORE MOTOR	FUSIBILE FUSE	TUBO TUBE	BOCCHIE PORTS	PESO WEIGHT
164 063 12	12	1,5	10A	180W	15A	16 mm	1/2" BSPP	3,4 kg
164 063 13	24	1,5	5A	180W	7,5A	16 mm	1/2" BSPP	3,4 kg

UP12-P

PEEK
GEARS



12V
24V

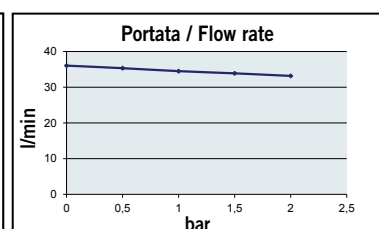
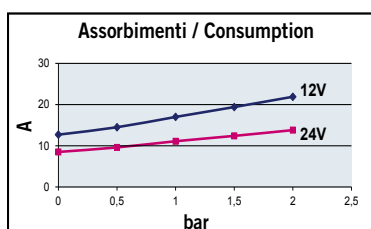
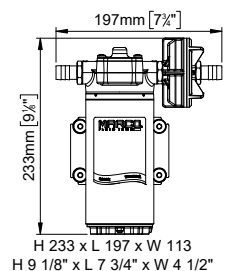

PORTATA
FLOW RATE
max.

PRESSIONE
PRESSURE
max.

36 l/min
9.5 gpm

2 bar
29 psi

CODICE PART NUMBER	VOLTS	ADESCAM. SELF-PRIM. m	CONS.	MOTORE MOTOR	FUSIBILE FUSE	TUBO TUBE	BOCCHIE PORTS	PESO WEIGHT
164 302 12	12	3	14A	360W	20A	16 mm	1/2" BSPP	4,3 kg
164 302 13	24	3	8A	360W	15A	16 mm	1/2" BSPP	4,3 kg

WATER AND FLUID TRANSFER PUMPS

UP12-PV

■ Integrated check valve

PEEK
GEARS



12V
24V

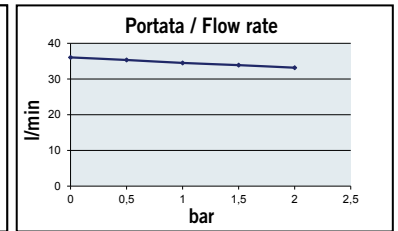
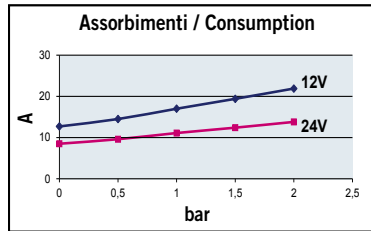
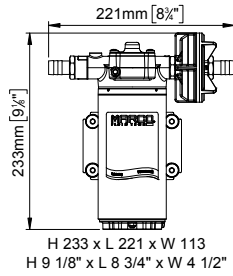

PORTATA FLOW RATE max.	PRESSIONE PRESSURE max.
36 l/min 9.5 gpm	2 bar 29 psi

CODICE PART NUMBER	VOLTS	ADESCAM. SELF-PRIM. m	CONS.	MOTORE MOTOR	FUSIBILE FUSE	TUBO TUBE	BOCCHE PORTS	PESO WEIGHT
164 304 12	12	3	14A	360W	20A	16 mm	1/2" BSPP	4,3 kg
164 304 13	24	3	8A	360W	15A	16 mm	1/2" BSPP	4,3 kg

UP14-P

■ High flow rate



12V
24V

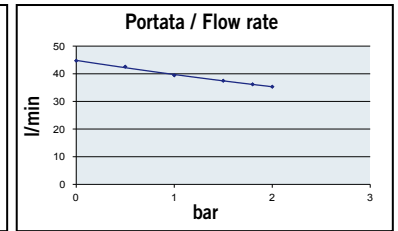
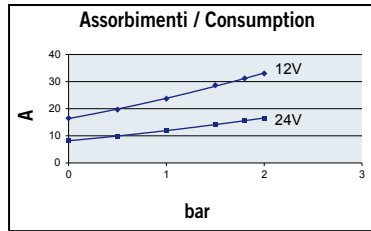
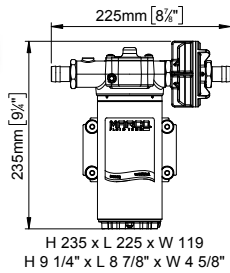

PORTATA FLOW RATE max.	PRESSIONE PRESSURE max.
46 l/min 12.2 gpm	2 bar 29 psi

CODICE PART NUMBER	VOLTS	ADESCAM. SELF-PRIM. m	CONS.	MOTORE MOTOR	FUSIBILE FUSE	TUBO TUBE	BOCCHE PORTS	PESO WEIGHT
164 502 12	12	3	16A	400W	30A	19 mm	3/4" BSPP	5 kg
164 502 13	24	3	8A	400W	20A	19 mm	3/4" BSPP	5 kg

UP14-PV

■ Integrated check valve



12V
24V

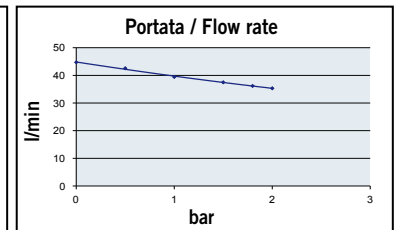
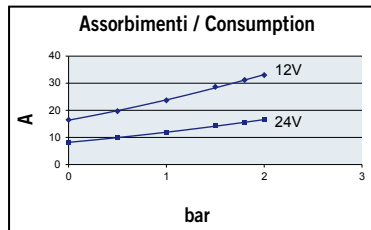
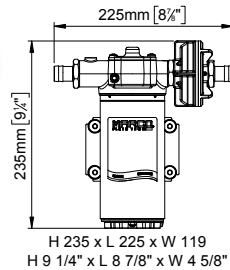

PORTATA FLOW RATE max.	PRESSIONE PRESSURE max.
46 l/min 12.2 gpm	2 bar 29 psi

CODICE PART NUMBER	VOLTS	ADESCAM. SELF-PRIM. m	CONS.	MOTORE MOTOR	FUSIBILE FUSE	TUBO TUBE	BOCCHE PORTS	PESO WEIGHT
164 504 12	12	3	16A	400W	30A	19 mm	3/4" BSPP	5 kg
164 504 13	24	3	8A	400W	20A	19 mm	3/4" BSPP	5 kg

UP8-P

- Heavy duty
- Compact footprint

PEEK
GEARS



12V
24V

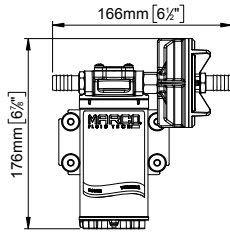

H 176 x L 166 x W 101 mm
H 6 7/8" x L 6 1/2" x W 4"

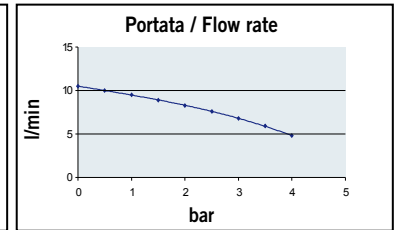
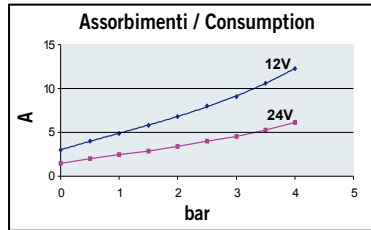

PORTATA
FLOW RATE
max.

PRESSIONE
PRESSURE
max.

10 l/min
2.6 gpm

4 bar
58 psi

HIGH PRESSURE

CODICE PART NUMBER	VOLTS	ADESCAM. SELF-PRIM. m	CONS.	MOTORE MOTOR	FUSIBILE FUSE	TUBO TUBE	BOCCHIE PORTS	PESO WEIGHT
164 091 12	12	1,5	4A	150W	10A	13 mm	3/8" BSPP	1,8 kg
164 091 13	24	1,5	2A	150W	5A	13 mm	3/8" BSPP	1,8 kg

UP8-XC

- Heavy duty
- Compact footprint
- Stainless steel AISI 316L

PEEK
GEARS



12V
24V

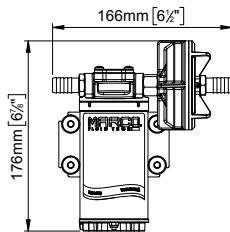

H 176 x L 166 x W 101 mm
H 6 7/8" x L 6 1/2" x W 4"

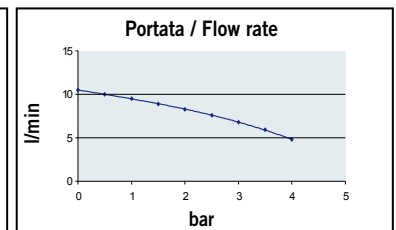
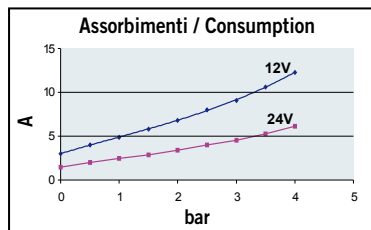

PORTATA
FLOW RATE
max.

PRESSIONE
PRESSURE
max.

10 l/min
2.6 gpm

4 bar
58 psi

HIGH PRESSURE

CODICE PART NUMBER	VOLTS	ADESCAM. SELF-PRIM. m	CONS.	MOTORE MOTOR	FUSIBILE FUSE	TUBO TUBE	BOCCHIE PORTS	PESO WEIGHT
164 094 12	12	1,5	4A	150W	10A	13 mm	3/8" BSPP	1,8 kg
164 094 13	24	1,5	2A	150W	5A	13 mm	3/8" BSPP	1,8 kg

UP9-P

PEEK
GEARS



12V
24V

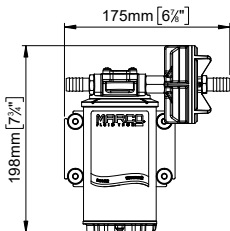

H 198 x L 175 x W 106
H 7 3/4" x L 6 7/8" x W 4 1/8"

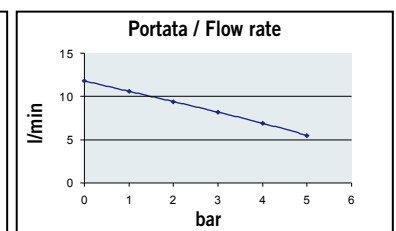
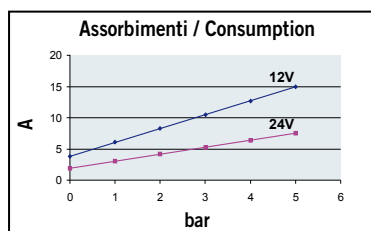

PORTATA
FLOW RATE
max.

PRESSIONE
PRESSURE
max.

12 l/min
3.2 gpm

5 bar
72.5 psi

HIGH PRESSURE

CODICE PART NUMBER	VOLTS	ADESCAM. SELF-PRIM. m	CONS.	MOTORE MOTOR	FUSIBILE FUSE	TUBO TUBE	BOCCHIE PORTS	PESO WEIGHT
164 102 12	12	1,5	5A	180W	15A	13 mm	3/8" BSPP	2,7 kg
164 102 13	24	1,5	3A	180W	7,5A	13 mm	3/8" BSPP	2,7 kg

WATER AND FLUID TRANSFER PUMPS

UP9-XC

▪ Stainless steel AISI 316L

PEEK GEARS



12V
24V

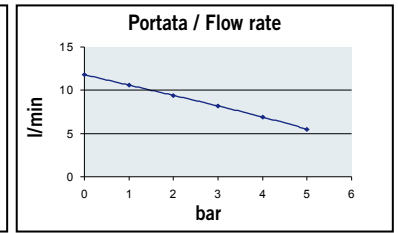
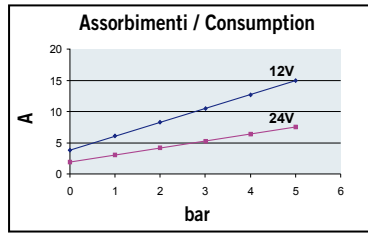
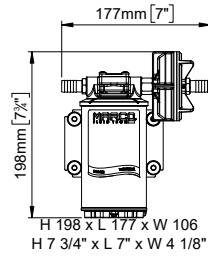

PORTATA
FLOW RATE
max.
12 l/min
3.2 gpm

PRESSIONE
PRESSURE
max.
5 bar
72.5 psi

HIGH PRESSURE

CODICE PART NUMBER	VOLTS	ADESCAM. SELF-PRIM. m	CONS.	MOTORE MOTOR	FUSIBILE FUSE	TUBO TUBE	BOCCHIE PORTS	PESO WEIGHT
164 101 12	12	1,5	5A	180W	15A	13 mm	3/8" BSPP	2,7 kg
164 101 13	24	1,5	3A	180W	7,5A	13 mm	3/8" BSPP	2,7 kg

UP9-XA

▪ Heavy duty ▪ Stainless steel AISI 316L

PEEK GEARS



12V
24V

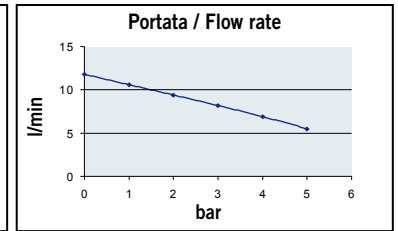
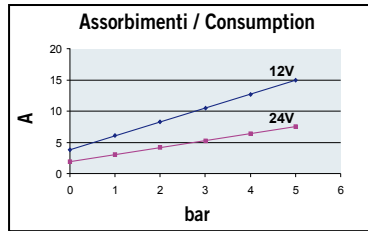
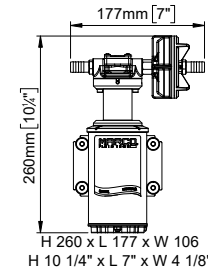

PORTATA
FLOW RATE
max.
12 l/min
3.2 gpm

PRESSIONE
PRESSURE
max.
5 bar
72.5 psi

HIGH PRESSURE

CODICE PART NUMBER	VOLTS	ADESCAM. SELF-PRIM. m	CONS.	MOTORE MOTOR	FUSIBILE FUSE	TUBO TUBE	BOCCHIE PORTS	PESO WEIGHT
164 103 12	12	1,5	5A	180W	15A	13 mm	3/8" BSPP	2,7 kg
164 103 13	24	1,5	3A	180W	7,5A	13 mm	3/8" BSPP	2,7 kg

UP9-XA/DM

▪ Heavy duty ▪ Stainless steel AISI 316L ▪ EPDM Lip seal

PEEK GEARS



12V
24V

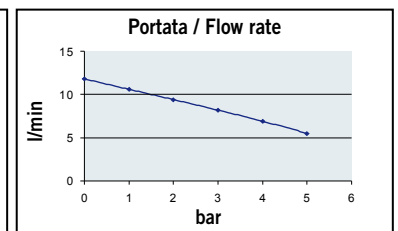
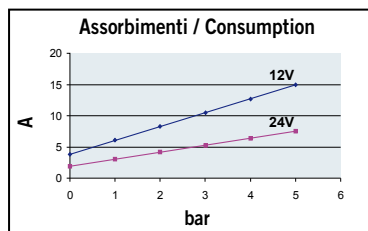
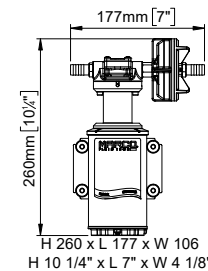

PORTATA
FLOW RATE
max.
12 l/min
3.2 gpm

PRESSIONE
PRESSURE
max.
5 bar
72.5 psi

HIGH PRESSURE

CODICE PART NUMBER	VOLTS	ADESCAM. SELF-PRIM. m	CONS.	MOTORE MOTOR	FUSIBILE FUSE	TUBO TUBE	BOCCHIE PORTS	PESO WEIGHT
164 106 12	12	1,5	5A	180W	15A	13 mm	3/8" BSPP	2,7 kg
164 106 13	24	1,5	3A	180W	7,5A	13 mm	3/8" BSPP	2,7 kg

POLYMER GEARS

UP10-P

PEEK
GEARS



12V
24V

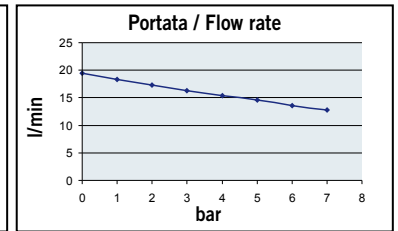
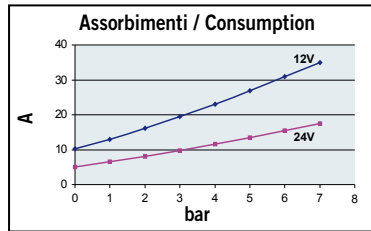
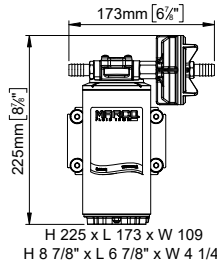

PORTATA
FLOW RATE
max.

PRESSIONE
PRESSURE
max.

18 l/min
4.8 gpm

7 bar
101.5 psi

HIGH PRESSURE

CODICE PART NUMBER	VOLTS	ADESCAM. SELF-PRIM. m	CONS.	MOTORE MOTOR	FUSIBILE FUSE	TUBO TUBE	BOCCHIE PORTS	PESO WEIGHT
164 402 12	12	3	11A	360W	25A	13 mm	3/8" BSPP	3,8 kg
164 402 13	24	3	5A	360W	20A	13 mm	3/8" BSPP	3,8 kg

UP10-XC

Stainless steel AISI 316L

PEEK
GEARS



12V
24V

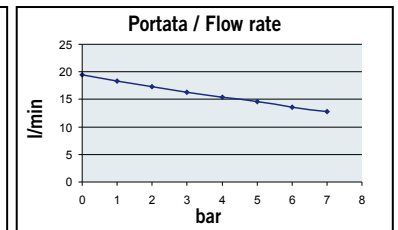
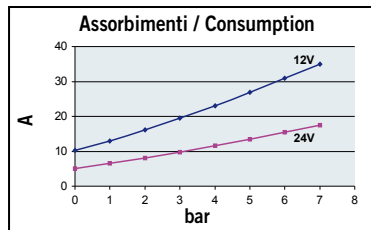
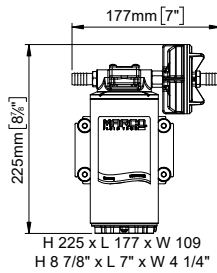

PORTATA
FLOW RATE
max.

PRESSIONE
PRESSURE
max.

18 l/min
4.8 gpm

7 bar
101.5 psi

HIGH PRESSURE

CODICE PART NUMBER	VOLTS	ADESCAM. SELF-PRIM. m	CONS.	MOTORE MOTOR	FUSIBILE FUSE	TUBO TUBE	BOCCHIE PORTS	PESO WEIGHT
164 401 12	12	3	11A	360W	25A	13 mm	3/8" BSPP	3,8 kg
164 401 13	24	3	5A	360W	20A	13 mm	3/8" BSPP	3,8 kg

UP10-XA

Heavy duty ■ Stainless steel AISI 316L

PEEK
GEARS



12V
24V

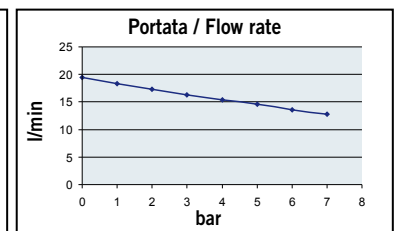
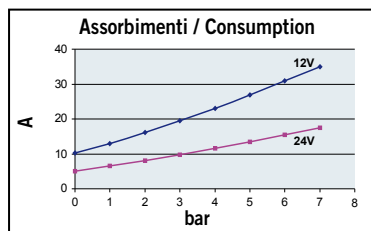
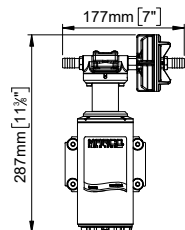

PORTATA
FLOW RATE
max.

PRESSIONE
PRESSURE
max.

18 l/min
4.8 gpm

7 bar
101.5 psi

HIGH PRESSURE

CODICE PART NUMBER	VOLTS	ADESCAM. SELF-PRIM. m	CONS.	MOTORE MOTOR	FUSIBILE FUSE	TUBO TUBE	BOCCHIE PORTS	PESO WEIGHT
164 403 12	12	3	11A	360W	25A	13 mm	3/8" BSPP	3,8 kg
164 403 13	24	3	5A	360W	20A	13 mm	3/8" BSPP	3,8 kg

WATER AND FLUID TRANSFER PUMPS

UP10-XA/DM

- Heavy duty
- Stainless steel AISI 316L
- EPDM Lip seal

PEEK GEARS



12V
24V

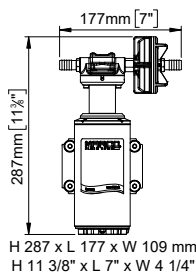

H 287 x L 177 x W 109 mm
H 11 3/8" x L 7" x W 4 1/4"

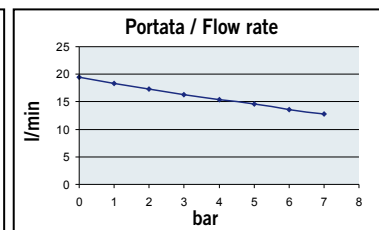
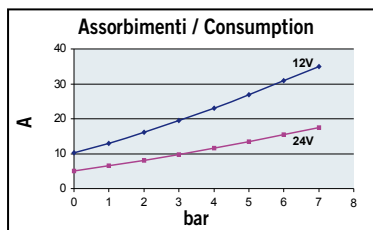

PORTATA
FLOW RATE
max.

18 l/min
4.8 gpm

PRESSIONE
PRESSURE
max.

7 bar
101.5 psi

HIGH PRESSURE

CODICE PART NUMBER	VOLTS	ADESCAM. SELF-PRIM. m	CONS.	MOTORE MOTOR	FUSIBILE FUSE	TUBO TUBE	BOCCHIE PORTS	PESO WEIGHT
164 406 12	12	3	11A	360W	25A	13 mm	3/8" BSPP	3,8 kg
164 406 13	24	3	5A	360W	20A	13 mm	3/8" BSPP	3,8 kg

Polymer Gears 230V - AC

UPX/AC

- Stainless steel AISI 316L
- Silicone O-rings

PEEK GEARS



230V

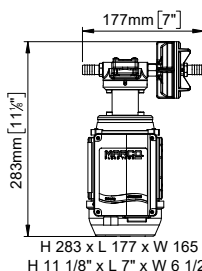

H 283 x L 177 x W 165
H 11 1/8" x L 7" x W 6 1/2"

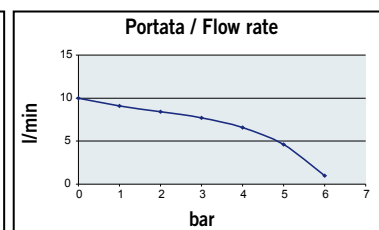
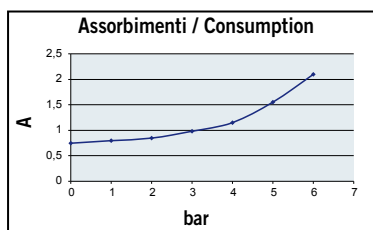

PORTATA
FLOW RATE
max.

10 l/min
2.6 gpm

PRESSIONE
PRESSURE
max.

6 bar
87 psi

CODICE PART NUMBER	VOLTS	ADESCAM. SELF-PRIM. m	CONS.	MOTORE MOTOR	FUSIBILE FUSE	TUBO TUBE	BOCCHIE PORTS	PESO WEIGHT
164 042 1C	230	1,5	0,8A	150W	2A	13 mm	3/8" BSPP	4,6 kg

UPX-C/AC

- Stainless steel AISI 316L

PEEK GEARS



230V

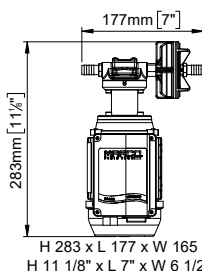

H 283 x L 177 x W 165
H 11 1/8" x L 7" x W 6 1/2"

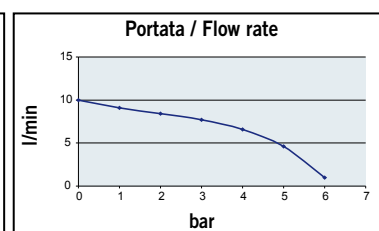
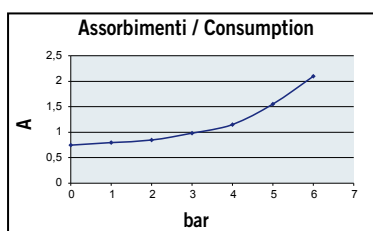

PORTATA
FLOW RATE
max.

10 l/min
2.6 gpm

PRESSIONE
PRESSURE
max.

6 bar
87 psi

CODICE PART NUMBER	VOLTS	ADESCAM. SELF-PRIM. m	CONS.	MOTORE MOTOR	FUSIBILE FUSE	TUBO TUBE	BOCCHIE PORTS	PESO WEIGHT
164 043 1C	230	1,5	0,8A	150W	2A	13 mm	3/8" BSPP	4,6 kg

Polymer Gears 12V, 24V and 230V Automatic Pressure Pumps

IT Elettropompe autoadescanti ad ingranaggi elicoidali in polimero, corredate di filtro in linea, valvola di non ritorno e pressostato, per impiego come pompe automatiche. Corpo in ottone nichelato, albero in acciaio inossidabile, tenute FKM e o-ring in NBR. Disponibili con vaso ad espansione integrato.

DE Selbstansaugende Elektropumpen mit Polymer-Schrägzahnradern, In-Line-Filter, Druckwächter und Rückschlagventil. Werden als automatische Pumpen verwendet. Gehäuse aus vernickeltem Messing, Spindel aus rostfreiem Stahl, Dichtungen aus FKM und O-Ring aus NBR. Auch mit integriertem Ausdehnungsgefäß erhältlich.

FR Pompes électriques auto-amorçantes avec engrenages hélicoïdaux en polymère, équipées de filtre en ligne, clapet anti-retour et pressostat pour emploi comme pompes automatiques. Corps en laiton nickelé, arbre en acier inoxydable, joint en FKM et O-Ring en NBR. Disponibles avec vase d'expansion intégré.

EN Self-priming electric pumps with polymer helical gears, equipped with inline filter, pressure switch, check valve, to be used as automatic pumps. Nickel-plated brass body, stainless steel shaft, FKM seals and NBR O-rings. Available with integrated accumulator tank.

ES Electrobombas auto-cebadas con engranajes helicoidales en polímero, provistas de filtro en línea, válvula de retención y presostato, para empleo como bombas automáticas. Cuerpo en latón niquelado, eje en acero inoxidable. Sellos en FKM y O-ring en NBR. Disponibles con acumulador de presión incorporado.

PT Bombas elétricas autoaspirantes com engrenagens helicoidais em polímero, equipadas com filtro em linha, pressostato e válvula de retenção, para emprego como bombas automáticas. Corpo em latão niquelado, eixo em aço inox. Selos em FKM y O-ring em NBR. Disponíveis com acumulador de pressão incorporado.

UP2/A



12V
24V

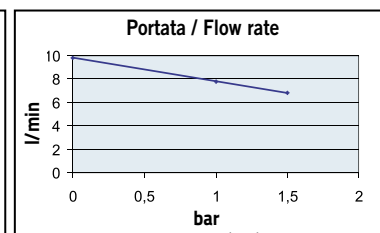
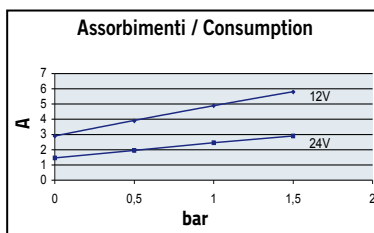
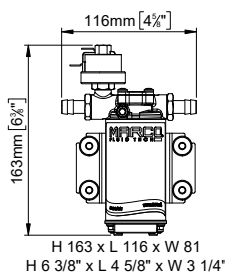

PORTATA FLOW RATE max.	PRESSIONE PRESSURE max.
10 l/min 2.6 gpm	1,5 bar 22 psi

CODICE PART NUMBER	VOLTS	ADESCAM. SELF-PRIM. m	CONS.	MOTORE MOTOR	FUSIBILE FUZE	TUBO TUBE	BOCCHE PORTS	PESO WEIGHT
164 662 12	12	1,5	3A	90W	7,5A	12 mm	3/8" BSPP	1,2 kg
164 662 13	24	1,5	1,5A	90W	4A	12 mm	3/8" BSPP	1,2 kg

UP3/A



12V
24V

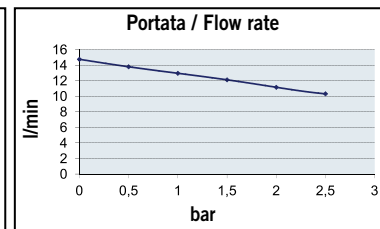
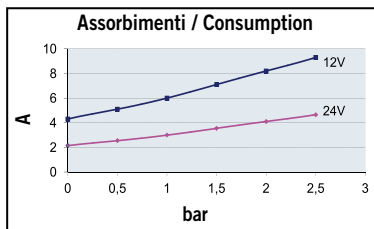
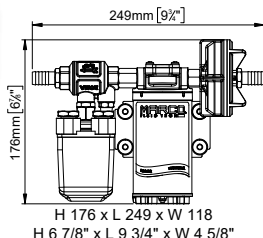

PORTATA FLOW RATE max.	PRESSIONE PRESSURE max.
15 l/min 4 gpm	2,5 bar 36.3 psi

CODICE PART NUMBER	VOLTS	ADESCAM. SELF-PRIM. m	CONS.	MOTORE MOTOR	FUSIBILE FUZE	TUBO TUBE	BOCCHE PORTS	PESO WEIGHT
164 600 12	12	1,5	6A	150W	10A	13 mm	3/8" BSPP	2,3 kg
164 600 13	24	1,5	3A	150W	5A	13 mm	3/8" BSPP	2,3 kg

PEEK
GEARS

WATER AND FLUID TRANSFER PUMPS

UP6/A

PEEK
GEARS



12V
24V

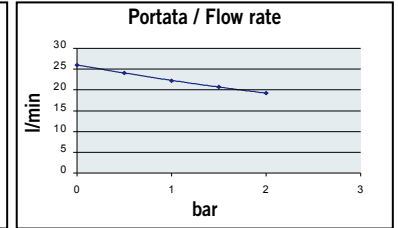
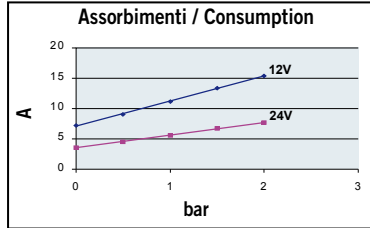
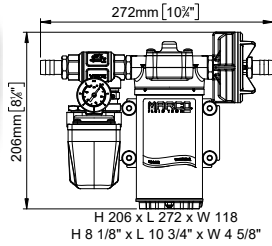

PORTATA FLOW RATE max.	PRESSIONE PRESSURE max.
26 l/min 6.9 gpm	2 bar 29 psi

CODICE PART NUMBER	VOLTS	ADESCAM. SELF-PRIM. m	CONS.	MOTORE MOTOR	FUSIBILE FUSE	TUBO TUBE	BOCCHIE PORTS	PESO WEIGHT
164 620 12	12	1,5	8A	180W	15A	16 mm	1/2" BSPP	4 kg
164 620 13	24	1,5	4A	180W	10A	16 mm	1/2" BSPP	4 kg

UP9/A

PEEK
GEARS



12V
24V

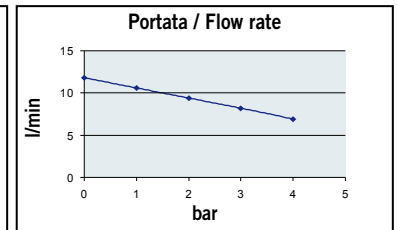
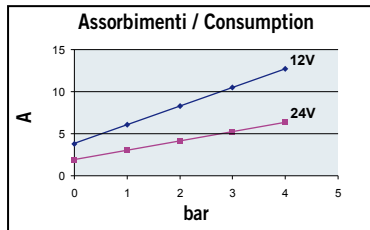
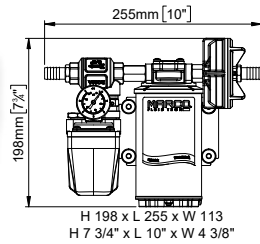

PORTATA FLOW RATE max.	PRESSIONE PRESSURE max.
12 l/min 3.2 gpm	4 bar 58 psi

HIGH PRESSURE

CODICE PART NUMBER	VOLTS	ADESCAM. SELF-PRIM. m	CONS.	MOTORE MOTOR	FUSIBILE FUSE	TUBO TUBE	BOCCHIE PORTS	PESO WEIGHT
164 640 12	12	1,5	5A	180W	15A	13 mm	3/8" BSPP	4 kg
164 640 13	24	1,5	3A	180W	10A	13 mm	3/8" BSPP	4 kg

UP12/A

PEEK
GEARS



24V

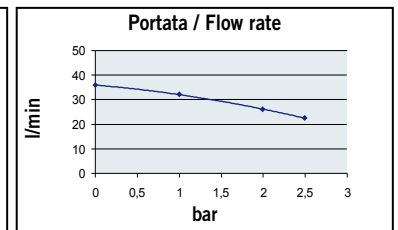
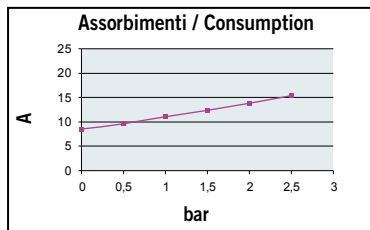
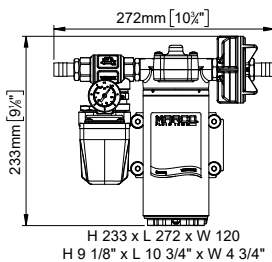

PORTATA FLOW RATE max.	PRESSIONE PRESSURE max.
36 l/min 9.5 gpm	2,5 bar 36 psi

CODICE PART NUMBER	VOLTS	ADESCAM. SELF-PRIM. m	CONS.	MOTORE MOTOR	FUSIBILE FUSE	TUBO TUBE	BOCCHIE PORTS	PESO WEIGHT
164 680 13	24	3	10A	360W	20A	16 mm	1/2" BSPP	5 kg

POLYMER GEARS

UP12/A-V5

PEEK GEARS

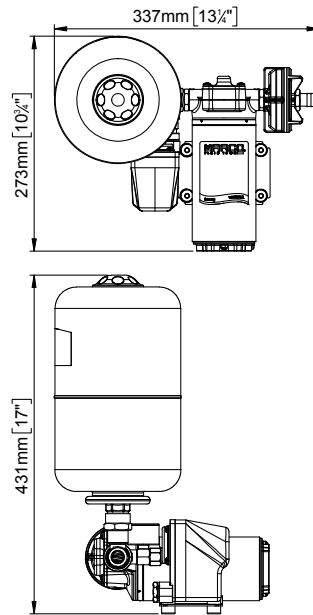

H 273 x L 337 x W 431
H 10 3/4" x L 13 1/4" x W 17"

24V

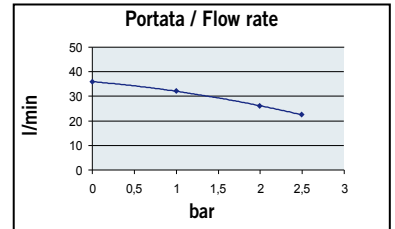
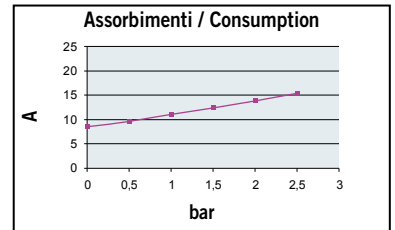

PORTATA
FLOW RATE
max.

36 l/min
9.5 gpm

PRESSIONE
PRESSURE
max.

2,5 bar
36 psi

CODICE
PART NUMBER

164 682 13

VOLTS

24

ADESCAM.
SELF-PRIM.
m

3

CONS.

10A

MOTORE
MOTOR

360W

FUSIBILE
FUSE

20A

TUBO
TUBE

16 mm

BOCCHIE
PORTS

1/2" BSPP

PESO
WEIGHT

7,1 kg

UP12/A-V20

PEEK GEARS

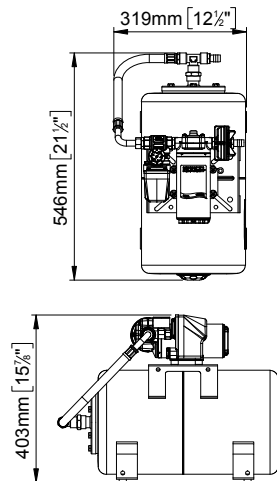

H 546 x L 319 x W 403
H 21 1/2" x L 12 1/2" x W 15 7/8"

24V

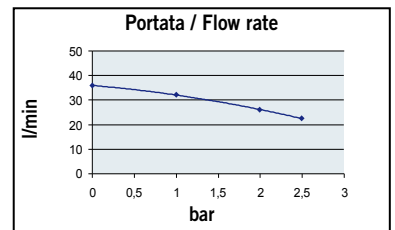
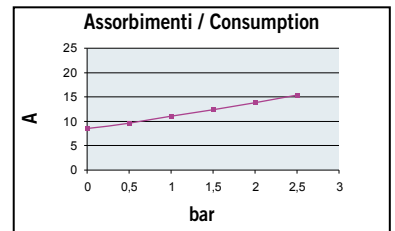

PORTATA
FLOW RATE
max.

36 l/min
9.5 gpm

PRESSIONE
PRESSURE
max.

2,5 bar
36 psi

CODICE
PART NUMBER

164 684 13

VOLTS

24

ADESCAM.
SELF-PRIM.
m

3

CONS.

10A

MOTORE
MOTOR

360W

FUSIBILE
FUSE

20A

TUBO
TUBE

16 mm

BOCCHIE
PORTS

1/2" BSPP

PESO
WEIGHT

11 kg

UP6/A-AC

PEEK
GEARS

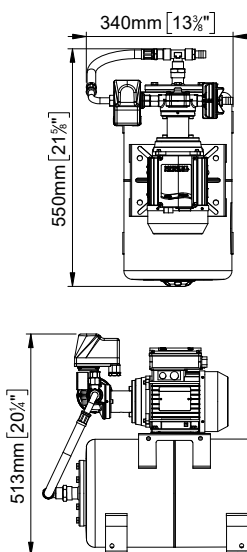

H 550 x L 340 x W 513
H 21 5/8" x L 12 3/8" x W 20 1/4"

230V

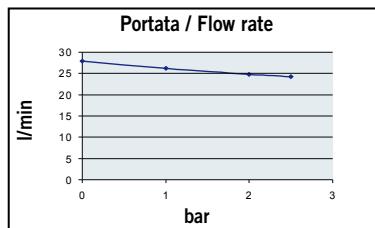
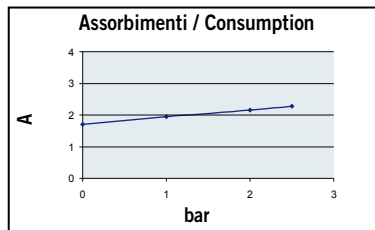

PORTATA
FLOW RATE
max.

28 l/min
7.4 gpm

PRESSIONE
PRESSURE
max.

2,5 bar
36 psi

CODICE
PART NUMBER

164 626 1C

VOLTS

230

ADESCAM.
SELF-PRIM.
m

1,5

CONS.

1,7A

MOTORE
MOTOR

550W

FUSIBILE
FUZE

2,5A

TUBO
TUBE

16 mm

BOCCHIE
PORTS

1/2" BSPP

PESO
WEIGHT

14 kg

Spare parts and
accessories

Page 66

ATX1



ATX2



AT1



AT2



WATER AND FLUID TRANSFER PUMPS

DP3

▪ Wash down kit with 15m/50ft retractable hose

PEEK
GEARS

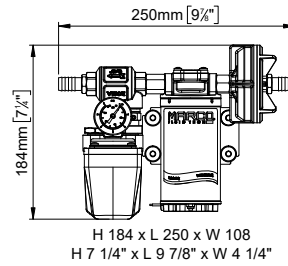

DQC Connection
see page 67



12V
24V

PORTATA
FLOW RATE
max.

PRESSIONE
PRESSURE
max.

14 l/min
3.7 gpm

3 bar
43.5 psi

CODICE PART NUMBER	VOLTS	ADESCAM. SELF-PRIM. m	CONS.	MOTORE MOTOR	FUSIBILE FUSE	TUBO TUBE	BOCCHIE PORTS	PESO WEIGHT
164 800 12	12	1,5	10A	150W	15A	13 mm	3/8" BSPP	2,2 kg
164 800 13	24	1,5	5A	150W	7,5A	13 mm	3/8" BSPP	2,2 kg

DP9

▪ Wash down kit with 15m/50ft retractable hose

PEEK
GEARS

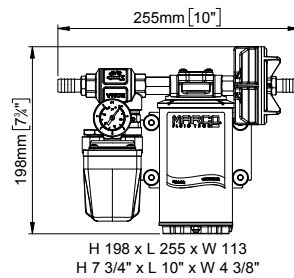

DQC Connection
see page 67



12V
24V

PORTATA
FLOW RATE
max.

PRESSIONE
PRESSURE
max.

12 l/min
3.2 gpm

4 bar
58 psi

HIGH PRESSURE

CODICE PART NUMBER	VOLTS	ADESCAM. SELF-PRIM. m	CONS.	MOTORE MOTOR	FUSIBILE FUSE	TUBO TUBE	BOCCHIE PORTS	PESO WEIGHT
164 820 12	12	1,5	12A	180W	15A	13 mm	3/8" BSPP	4 kg
164 820 13	24	1,5	6A	180W	10A	13 mm	3/8" BSPP	4 kg

DP12

▪ Wash down kit with 15m/50ft retractable hose

PEEK
GEARS

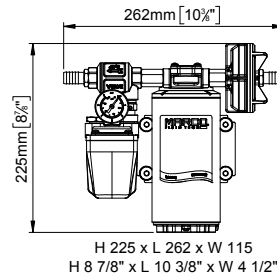

DQC Connection
see page 67



12V
24V

PORTATA
FLOW RATE
max.

PRESSIONE
PRESSURE
max.

15 l/min
4 gpm

5 bar
72.5 psi

HIGH PRESSURE

CODICE PART NUMBER	VOLTS	ADESCAM. SELF-PRIM. m	CONS.	MOTORE MOTOR	FUSIBILE FUSE	TUBO TUBE	BOCCHIE PORTS	PESO WEIGHT
164 840 12	12	3	24A	360W	30A	13 mm	3/8" BSPP	6 kg
164 840 13	24	3	12A	360W	20A	13 mm	3/8" BSPP	6 kg

Impeller Pumps

 [Link to video](#)
page 69



ISO 8849
ISO 8846

FLEXIBLE IMPELLER



REVERSIBLE



IT Elettropompe autoadescanti con girante flessibile in gomma. La girante in gomma garantisce alta portata e permette il passaggio di piccole impurità contenute nelle acque grigie. Disponibili con portate da 28 l/min a 45 l/min e in versioni con interruttore o deviatore integrati. Dotate di portaspazzole interno con filtro antidisturbo EMI, calotta impermeabile e passacavo stagno. Corpo in ottone nichelato, albero in acciaio inossidabile. Tenute in FKM e O-ring in NBR. ISO 8849 e ISO 8846.

DE Selbstansaugende Elektropumpen mit flexiblem Schaufelrad aus Nitrilgummi. Das Schaufelrad aus Gummi garantiert für eine hohe Leistung und erlaubt das Vorbeifließen von kleinen Unreinheiten, die in Grauwasser vorhanden sind. Jetzt verfügbar mit Förderleistung 28l/min und 45l/min. Erhältlich entweder mit integriertem Ein- und Aus Schalter oder 3-Positionen-Schalter. Wird mit internem Bürstenhalter mit EMI-Filter, wasserdichtem Deckel und Kabeldurchgang geliefert. Gehäuse aus vernickeltem Messing, Spindel aus rostfreiem Stahl. Dichtungen aus FKM und O-Ring aus NBR. ISO 8849 und ISO 8846.

FR Pompes électriques auto-amorçantes avec rotor flexible vulcanisé. Le rotor assure un débit élevé et permet le passage de petites impuretés dans les eaux usées. Disponibles avec capacités de 28 l / min jusqu'à 45 l / min et en versions avec interrupteur ou déviateur intégrés. Corps en laiton nickelé, arbre en acier inoxydable, joint en FKM et O-Ring en NBR. Le port balais se trouve à l'intérieur, protégé par une calotte avec galoche, joint et filtre EMI. ISO 8849 ET ISO 8846.

EN Self-priming electric pumps with rubber impeller. The rubber impeller guarantees a high flow rate and allows the passage of small impurities in wastewaters. Available with capacities from 28l/min up to 45 l/min and in versions with integrated on-off switch or flow reverser switch. Nickel-plated brass body and stainless steel shaft, FKM seals and NBR O-rings. Fitted with waterproof cable guide and internal brush holder with EMI filter. ISO 8846 and ISO 8849.

ES Electrobombas auto-cebadas con impulsor vulcanizado. El impulsor asegura un caudal elevado y permite el paso de pequeñas impurezas en el agua residual. Disponibles con capacidades desde 28 l/min hasta a 45 l/min y en versiones con interruptor o desviador de flujo integrados. Cuerpo en latón niquelado, eje en acero inoxidable, sellos en FKM y O-ring and NBR. Equipadas con pasa-cable impermeable y porta-escobillas interno con filtro EMI. ISO 8846 e ISO 8849.

PT Eletrobombas autoaspirantes com impulsor de borracha. O impulsor garante um fluxo elevado e a passagem de pequenas impurezas contidas na água de resíduos. Agora disponíveis em 3 dimensões com capacidades de 28 l/min até 45 l/min e em versões com interruptor on-off ou desviador de fluxo integrados. Corpo em latão niquelado, eixo em aço inox. Selos em FKM y O-ring em NBR. Porta-escovas interno com filtro EMI, tampa impermeável e passa fios hermético. ISO 8849 e ISO 8846.

Impeller Pumps 12V and 24V - DC

UP1-J



12V
24V

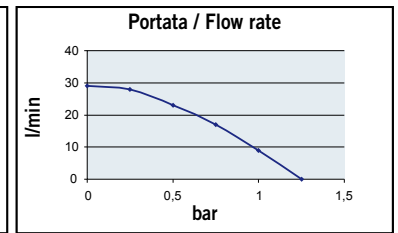
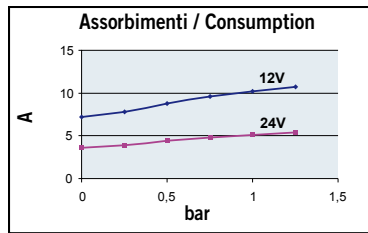
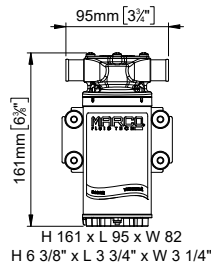

PORTATA FLOW RATE max.	PRESSIONE PRESSURE max.	CODICE PART NUMBER	VOLTS	ADESCAM. SELF-PRIM. m	CONS.	MOTORE MOTOR	FUSIBILE FUSE	TUBO TUBE	BOCCHIE PORTS	PESO WEIGHT
28 l/min 7.4 gpm	1 bar 14.5 psi	162 004 12	12	1,5	8A	150W	10A	20 mm	3/8" BSPP	1,8 kg
		162 004 13	24	1,5	4A	150W	7,5A	20 mm	3/8" BSPP	1,8 kg

UP1-JS

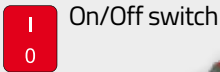

On/Off switch



12V
24V

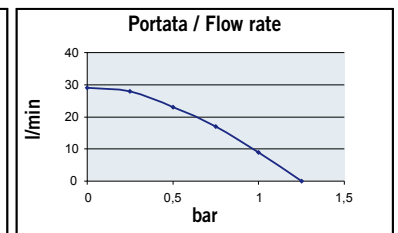
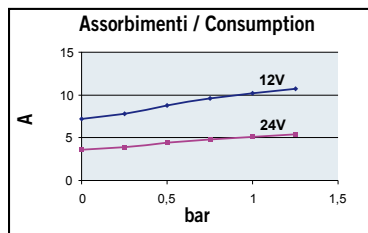
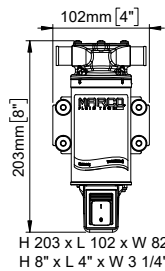

PORTATA FLOW RATE max.	PRESSIONE PRESSURE max.	CODICE PART NUMBER	VOLTS	ADESCAM. SELF-PRIM. m	CONS.	MOTORE MOTOR	FUSIBILE FUSE	TUBO TUBE	BOCCHIE PORTS	PESO WEIGHT
28 l/min 7.4 gpm	1 bar 14.5 psi	162 010 12	12	1,5	8A	150W	10A	20 mm	3/8" BSPP	1,8 kg
		162 010 13	24	1,5	4A	150W	7,5A	20 mm	3/8" BSPP	1,8 kg

UP1-JR

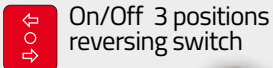

On/Off 3 positions reversing switch



12V
24V

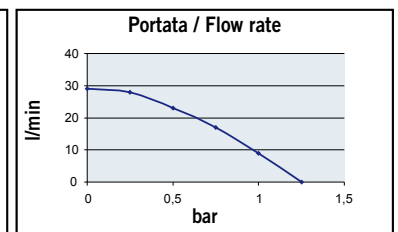
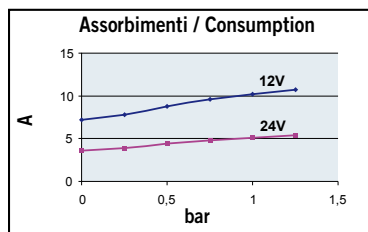
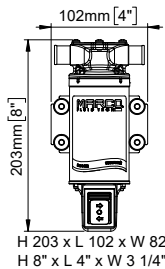

PORTATA FLOW RATE max.	PRESSIONE PRESSURE max.	CODICE PART NUMBER	VOLTS	ADESCAM. SELF-PRIM. m	CONS.	MOTORE MOTOR	FUSIBILE FUSE	TUBO TUBE	BOCCHIE PORTS	PESO WEIGHT
28 l/min 7.4 gpm	1 bar 14.5 psi	162 011 12	12	1,5	8A	150W	10A	20 mm	3/8" BSPP	1,8 kg
		162 011 13	24	1,5	4A	150W	7,5A	20 mm	3/8" BSPP	1,8 kg

WATER AND FLUID TRANSFER PUMPS

UP1



12V
24V

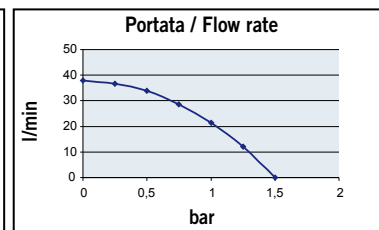
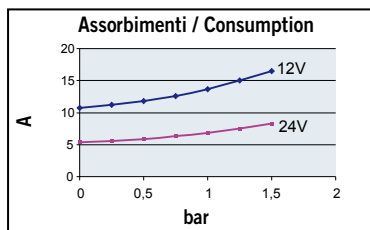
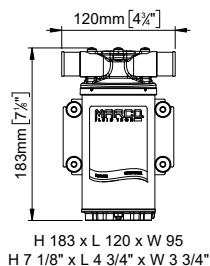

PORTATA
FLOW RATE
max. **35 l/min**
9.2 gpm

PRESSIONE
PRESSURE
max. **1,2 bar**
17.4 psi

CODICE PART NUMBER	VOLTS	ADESCAM. SELF-PRIM. m	CONS.	MOTORE MOTOR	FUSIBILE FUSE	TUBO TUBE	BOCCHIE PORTS	PESO WEIGHT
162 002 12	12	1,5	10A	180W	20A	25 mm	1/2" BSPP	2,9 kg
162 002 13	24	1,5	5A	180W	15A	25 mm	1/2" BSPP	2,9 kg

UP1-M



12V
24V

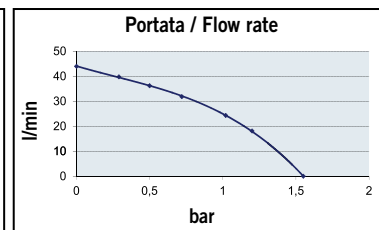
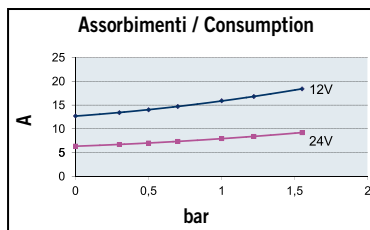
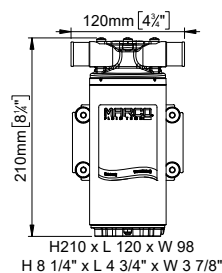

PORTATA
FLOW RATE
max. **45 l/min**
11.9 gpm

PRESSIONE
PRESSURE
max. **1,5 bar**
21.8 psi

CODICE PART NUMBER	VOLTS	ADESCAM. SELF-PRIM. m	CONS.	MOTORE MOTOR	FUSIBILE FUSE	TUBO TUBE	BOCCHIE PORTS	PESO WEIGHT
162 006 12	12	1,5	14A	360W	20A	25 mm	1/2" BSPP	4,1 kg
162 006 13	24	1,5	7A	360W	15A	25 mm	1/2" BSPP	4,1 kg

UP1-B



12V
24V

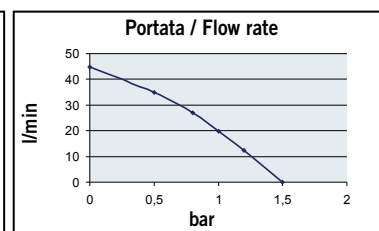
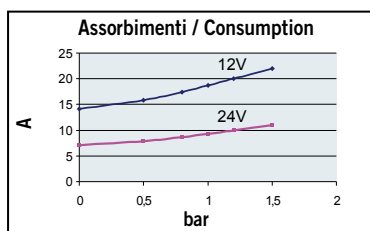
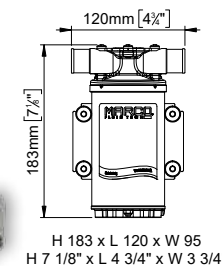

PORTATA
FLOW RATE
max. **45 l/min**
11.9 gpm

PRESSIONE
PRESSURE
max. **1,5 bar**
21.8 psi

CODICE PART NUMBER	VOLTS	ADESCAM. SELF-PRIM. m	CONS.	MOTORE MOTOR	FUSIBILE FUSE	TUBO TUBE	BOCCHIE PORTS	PESO WEIGHT
162 003 12	12	1,5	14A	180W	20A	25 mm	1/2" BSPP	2,9 kg
162 003 13	24	1,5	7A	180W	15A	25 mm	1/2" BSPP	2,9 kg



OPTIONAL

RCS Control Panel (page 32)

- Reversible
- Ideal for ballast applications

Impeller Pumps 110V and 230V - AC

UP1/AC



230V
110V

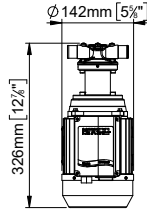

H 326 x L 142 x W 195
H 12 7/8" x L 5 5/8" x W 7 5/8"

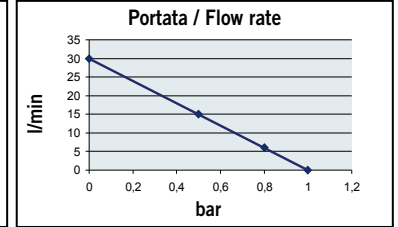
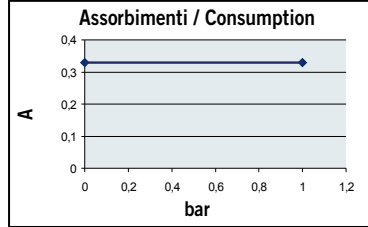

	PORTATA FLOW RATE max.	PRESSIONE PRESSURE max.	CODICE PART NUMBER	VOLTS	ADESCAM. SELF-PRIM. m	CONS.	MOTORE MOTOR	FUSIBILE FUZE	TUBO TUBE	BOCCHIE PORTS	PESO WEIGHT
230V	30 l/min 7.9 gpm	1 bar 14.5 psi	162 001 1C	230	1,5	3,3A	550W	4A	25 mm	1/2" BSPP	7,3 kg
110V	36 l/min 9.5 gpm	1 bar 14.5 psi	162 001 1B	110	1,5	7A	550W	8A	25 mm	1/2" BSPP	7,3 kg

110V VERSION: M.O.Q. 20 PCS

Spare parts and accessories

Page 65



Submersible Pumps 12V and 24V - DC



IT Elettropompe ad immersione per svuotamento ad alta portata e bassa prevalenza. Involucro in robusto ABS antiurto, resistente alla corrosione ed alla elettrolisi.

DE Elektrische Tauchpumpe für Entleerung mit hoher Förderleistung und niedriger Förderhöhe. Das Gehäuse ist aus robustem Antistoß-ABS, beständig gegen Korrosion und Elektrolyse.

FR Pompes immergées pour opérations de vidange. Haut débit et basse pression. Corps de robuste ABS antichoc, résistant à la corrosion et à l'électrolyse.

EN Submersible pumps, especially fit for emptying operations. High flow and low head. Compact design with ABS housing, corrosion and electrolysis resistant.

ES Electrobombas sumergibles para operaciones de vaciamiento. Alta capacidad y baja prevalencia. Cuerpo en robusto ABS resistente a la corrosión y a la electrólisis.

PT Bombas submersíveis para operações de esvaziamento. Alta capacidade e baixa pressão. Carcaça em ABS reforçado, resistente à corrosão e eletrólise.

UP500

■ ISO 8849 ■ ISO 8846



12V
24V

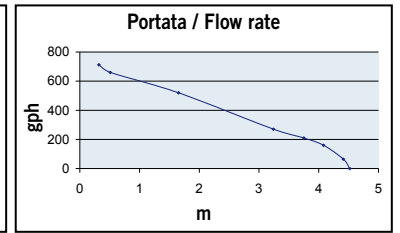
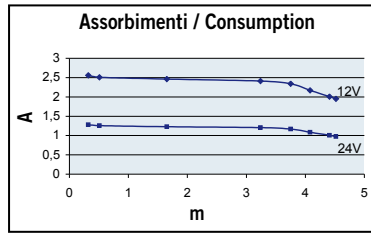
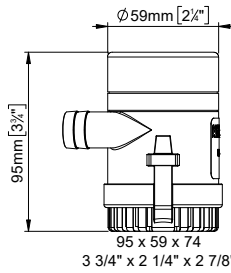

PORTATA
FLOW RATE
max.

32 l/min
500 gph

PRESSIONE
PRESSURE
max.

0,4 bar
5.8 psi

CODICE PART NUMBER	VOLTS	PREVALENZA LIFT	CONS.	MOTORE MOTOR	FUSIBILE FUZE	TUBO TUBE	PESO WEIGHT
160 100 12	12	4 m	2,5A	30W	5A	19 mm	0,5 kg
160 100 13	24	4 m	1,2A	30W	3A	19 mm	0,5 kg

UP1000

■ ISO 8849 ■ ISO 8846



12V
24V

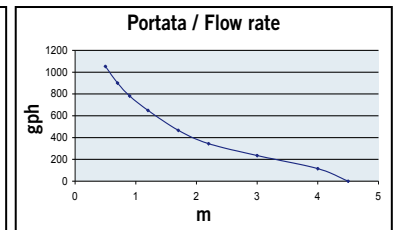
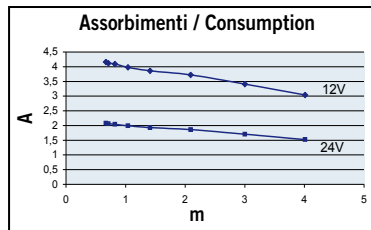
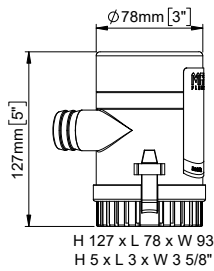

PORTATA
FLOW RATE
max.

63 l/min
1000 gph

PRESSIONE
PRESSURE
max.

0,4 bar
5.8 psi

CODICE PART NUMBER	VOLTS	PREVALENZA LIFT	CONS.	MOTORE MOTOR	FUSIBILE FUZE	TUBO TUBE	PESO WEIGHT
160 120 12	12	4 m	4A	50W	10A	30 mm	1 kg
160 120 13	24	4 m	2A	50W	5A	30 mm	1 kg

UP1500

■ Heavy duty ■ ISO 8849 ■ ISO 8846



12V
24V

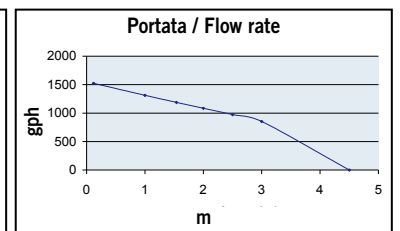
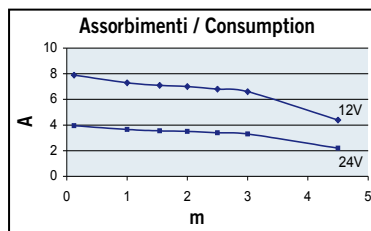
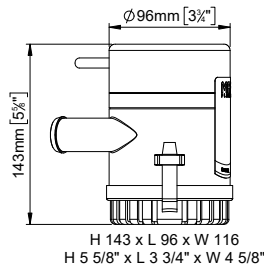

PORTATA
FLOW RATE
max.

95 l/min
1500 gpm

PRESSIONE
PRESSURE
max.

0,4 bar
5.8 psi

CODICE PART NUMBER	VOLTS	PREVALENZA LIFT	CONS.	MOTORE MOTOR	FUSIBILE FUZE	TUBO TUBE	PESO WEIGHT
160 140 12	12	4 m	10A	120W	20A	30 mm	1,5 kg
160 140 13	24	4 m	5A	120W	10A	30 mm	1,5 kg

WATER AND FLUID TRANSFER PUMPS

UP2000

- Heavy duty
- ISO 8849
- ISO 8846



12V
24V

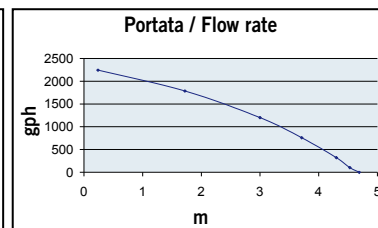
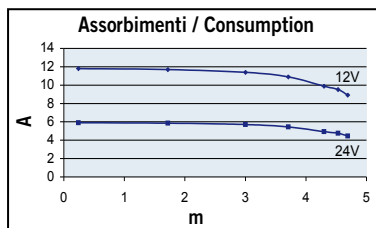
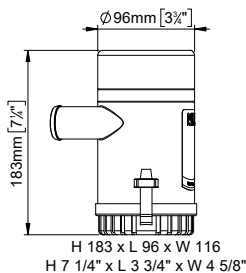

PORTATA FLOW RATE max.	PRESSIONE PRESSURE max.
126 l/min 2000 gph	0,4 bar 5.8 psi

CODICE PART NUMBER	VOLTS	PREVALENZA LIFT	CONS.	MOTORE MOTOR	FUSIBILE FUSE	TUBO TUBE	PESO WEIGHT
160 160 12	12	4 m	12A	150W	25A	32 mm	2 kg
160 160 13	24	4 m	6A	150W	15A	32 mm	2 kg

UP3700

- Heavy duty
- ISO 8849
- ISO 8846



24V

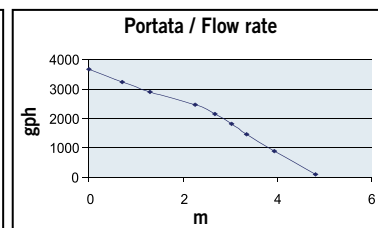
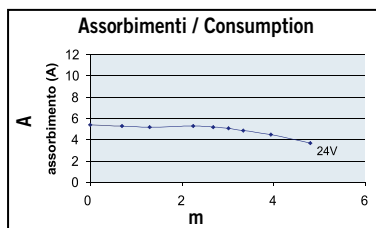
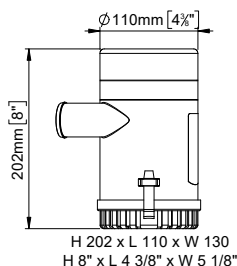

PORTATA FLOW RATE max.	PRESSIONE PRESSURE max.
233 l/min 3700 gph	0,5 bar 7.3 psi

CODICE PART NUMBER	VOLTS	PREVALENZA LIFT	CONS.	MOTORE MOTOR	FUSIBILE FUSE	TUBO TUBE	PESO WEIGHT
160 180 13	24	5 m	6A	200W	10A	38 mm	3,2 kg

Spare parts and accessories

AS2



AS3



AS2

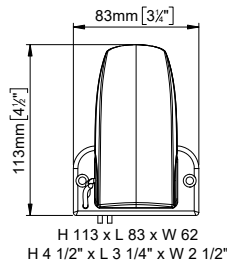

- | | |
|--|--|
| IT Interruttore automatico per controllo pompe ad immersione. | EN Automatic float switch for submersible pumps. |
| DE Automatischer Schalter zur Überwachung der Tauchpumpen. | ES Interruptor automático para controlar bombas sumergibles. |
| FR Contacteur automatique pour pompes immergées. | PT Interruptor automático para controlar bombas submergíveis. |

CODICE PART NUMBER	AMP.	OFF/ON	CAVO WIRE	DIMENSIONI DIMENSIONS mm
161 002 20	max. 10	25/55 mm	850 mm	113 x 83 x 62

AS3

NEW

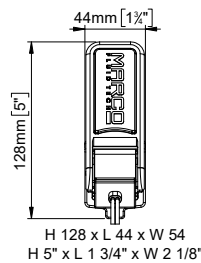

▪ Heavy duty

- | | |
|---|--|
| IT Interruttore automatico per pompe sentina . Ideale per servizi gravosi. | EN Automatic float switch for bilge pumps - Heavy Duty. |
| DE Automatischer Schalter für Lenzumpen - Heavy Duty. | ES Interruptor automático para bombas de achique - Servicios pesados. |
| FR Interrupteur automatique pour pompes vide de cale - Services lourds. | PT Interruptor automático para bombas de porão - Serviços pesados |

CODICE PART NUMBER	AMP. max.	OFF/ON	CAVO WIRE	DIMENSIONI DIMENSIONS mm
161 003 10	14 (12V) - 7 (24V)	19/51 mm	900 mm	127 x 42 x 110

IMP1



CODICE PART NUMBER	MATERIALE MATERIAL	RICAMBIO ORIGINALE PER ORIGINAL SPARE PART FOR	DIMENSIONI DIMENSIONS mm	FORO BORE mm
163 000 00	Gomma nitrilica Nitrile rubber	UP1 - UP1/N - UP1/M - UP1/AC	Ø 51,5 x 22	8

IMP2



CODICE PART NUMBER	MATERIALE MATERIAL	RICAMBIO ORIGINALE PER ORIGINAL SPARE PART FOR	DIMENSIONI DIMENSIONS mm	FORO BORE mm
163 001 00	Gomma nitrilica Nitrile rubber	UP1/J	Ø 40,5 x 22	8

IMP2/V



CODICE PART NUMBER	MATERIALE MATERIAL	RICAMBIO ORIGINALE PER ORIGINAL SPARE PART FOR	DIMENSIONI DIMENSIONS mm	FORO BORE mm
163 002 00	FKM	UP1/J	Ø 40,5 x 22	8

PUMP ACCESSORIES

ATX1

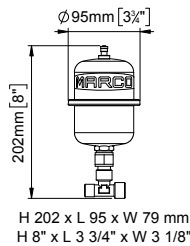

0,5liters

ATX2

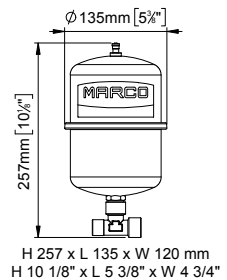

2 liters

IT Vasi ad espansione in acciaio inox per pompe automatiche. Attacco in acciaio inox. Membrana in gomma per liquidi alimentari.

DE Ausdehnungsgefäße aus Edelstahl für automatische Pumpen. Verbindungsstück aus Edelstahl. Membran aus Gummi zur Benutzung von flüssigen Lebensmitteln.

FR Vases d'expansion en acier inoxydable pour pompes automatiques. Connexion en acier inoxydable. Membrane en caoutchouc pour liquides alimentaires.

EN Stainless steel accumulator tanks for automatic pumps. Stainless steel port. Rubber membrane suitable for foodstuffs.

ES Acumuladores de presión en acero inox para bombas automáticas. Conexión en acero inox. Membrana en goma para líquidos alimenticios.

PT Acumuladores de pressão em aço inox para bombas automáticas. Ligação em aço inox. Membrana em borracha para líquidos alimentares.

TIPO TYPE	CODICE PART NUMBER	FINITURA FINISHING	CAPACITÀ CAPACITY litri / liters	PRESSIONE PRESSURE std max	DIMENSIONI DIMENSIONS	BOCCA CONNECT
ATX1	165 080 10	acciaio inox stainless steel	0,5	1 bar 14.5 psi	10 bar 145 psi	Ø95x202 3/8" BPS
ATX1	165 080 11	acciaio inox stainless steel	0,5	1 bar 14.5 psi	10 bar 145 psi	Ø95x202 1/2" BPS
ATX2	165 081 10	acciaio inox stainless steel	2	1 bar 14.5 psi	10 bar 145 psi	Ø138x274 1/2" BPS

AT1

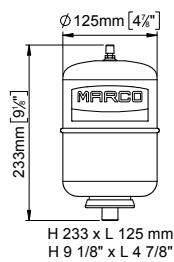

2 liters

AT2

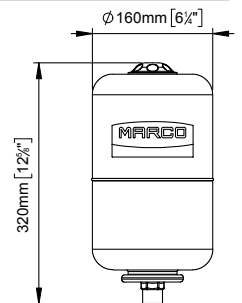

5 liters

IT Vasi ad espansione per pompe automatiche, verniciati bianchi. Attacco in acciaio inox. Membrana in gomma per liquidi alimentari.

DE Ausdehnungsgefäße für automatische Pumpen, weiß-lackiert. Verbindungsstück aus Edelstahl. Membran aus Gummi zur Benutzung von flüssigen Lebensmitteln.

FR Vases d'expansion pour pompes automatiques, vernissés blancs. Connexion en acier inoxydable. Membrane en caoutchouc pour liquides alimentaires.

EN Accumulator tanks for automatic pumps, white-painted. Stainless steel port. Rubber membrane suitable for foodstuffs.

ES Acumuladores de presión para bombas automáticas, barnizados blancos. Conexión en acero inox. Membrana en goma para líquidos alimenticios.

PT Acumuladores de pressão para bombas automáticas, pintados em branco. Ligação em aço inox. Membrana em borracha para líquidos alimentares.

TIPO TYPE	CODICE PART NUMBER	FINITURA FINISHING	CAPACITÀ CAPACITY litri / liters	PRESSIONE PRESSURE std max	DIMENSIONI DIMENSIONS	BOCCA CONNECT
AT1	165 082 10	verniciato bianco white painted	2	1,3 bar 18.9 psi	10 bar 145 psi	Ø125x239 3/8" BPS
AT2	165 083 10	verniciato bianco white painted	5	1,3 bar 18.9 psi	8 bar 116 psi	Ø165x306 1/2" BPS

DHK1



Heavy duty

IT Kit tubo per pompa lavaggio ponte estensibile fino a 15 m, pistola e connessione da 3/4". Raccordi e connessione in ottone nichelato compatibile con DQC.

DE Ausziehbarer Schlauch für Deckwaschpumpe, erweiterbar bis 15m, Spritzpistole, 3/4" Anschluss. Rohrverbindungsstück und Schnellverbindung aus vernickeltem Messing, kompatibel mit DQC.

FR Kit de tuyau pour pompe à laver, tuyau rétractable de 15 m, pistolet, raccord 3/4". Raccords et connexion rapide en laiton nickelé compatible avec DQC.

EN Deck hose kit with 15m/50ft retractable hose, spray gun, 3/4" connection. Nickel plated brass fittings and quick connection suitable for DQC.

ES Kit de tubo para bomba de cubierta, con tubo retráctil de 15 m, pistola, conexión de 3/4". Rcores y conexión rápida en latón niquelado compatible con DQC.

PT Kit de tubo para bomba de lavagem com tubo retrátil de 15 m, pistola, conexão de 3/4". Ligações e conexão rápida em latão niquelado compatível com DQC.

TIPO TYPE	CODICE PART NUMBER	DESCRIZIONE DESCRIPTION	RACCORDI FITTINGS
DHK1	165 101 00	Tubo estensibile fino a 15 m, pistola e connessione rapida 15 m/50 ft retractable hose, spray gun, quick connection	3/4" BSPP

DQC



Heavy duty

IT Connessione rapida a scatto per pompe di lavaggio DP. Estremamente semplice da installare. Compatibile con tubo DHK1.

DE Schnellverbindung mit Klick für Deckwaschpumpe. Äußerst einfach zu montieren. Kompatibel mit Schlauch DHK1.

FR Connexion rapide à déclenchement pour pompes de lavage DP. Très facile à installer. Compatible avec tuyau DHK1.

EN Quick-click connection for DP washing pumps. Very easy to install. Suitable for DHK1 hose.

ES Conexión rápida a presión para bombas de lavado DP. Muy fácil de instalar. Compatible con tubo DHK1.

PT Ligaçãõ rápida de encaixe para bombas de lavagem. Muito fácil de instalar. Compatível com tubo DHK1.

TIPO TYPE	CODICE PART NUMBER	DIMENSIONI DIMENSIONS mm	CONNESSIONI CONNECTION	FORO HOLE
DQC	165 100 00	90x84x55	int. Ø 12.5 ÷ 15,5	Ø78

IS14 IS16



IT Filtro in linea in nylon trasparente con parte filtrante in acciaio inox AISI 304. Chiusura a scatto per una facile ispezione e pulizia.

DE Angeschlossener Filter aus durchsichtigem Nylon mit Filternetz aus Edelstahl AISI 304. Druckverschluss für eine einfache Reinigung.

FR Filtre en ligne de nylon transparent avec grille filtrante en acier inoxydable AISI 304. Déclenchement rapide pour faciliter l'inspection et le nettoyage.

EN In-line filter made of transparent nylon with AISI 304 stainless steel net. Snap-on locking for easy inspection and cleaning.

ES Filtro en línea de nylon transparente con rejilla de acero inoxidable AISI 304. Gran facilidad de desmontaje para su limpieza.

PT Filtro em linha de nylon transparente com rede de aço inoxidável AISI 304. Grande facilidade de desmontagem para a limpeza.

TIPO TYPE	CODICE PART NUMBER	RACCORDI CONNECTIONS	TUBO TUBE	MATERIALE MATERIAL	O-RING	GRIGLIA NET
IS14	165 000 10	3/8" BSP	Ø14 mm interno Ø14 mm inner tubing	PA6	NBR	0,5x0,5
IS14	165 002 10	3/8" BSP	Ø14 mm interno Ø14 mm inner tubing	PA6	FKM	0,5x0,5
IS14	165 003 10	3/8" BSP	Ø14 mm interno Ø14 mm inner tubing	PA6	SILICONE	0,5x0,5
IS16	165 001 10	1/2" BSP	Ø16 mm interno Ø16 mm inner tubing	PA6	NBR	0,5x0,5
IS20	165 004 10	3/4" BSP	Ø20 mm interno Ø20 mm inner tubing	PA6	NBR	0,5x0,5

PUMP ACCESSORIES

OK1



Part No. 165 020 00

IT Kit tubi Ø 8 mm e 6 mm esterno per pompe travaso olio.

DE Schlauchkit Ø 8 mm und 6 mm für Ölpumpen.

FR Kit de tuyaux Ø 8 mm et 6 mm ext. pour transvasement d'huiles.

EN Tube kit of 8 mm and 6 mm ext. Ø for oil pumps.

ES Kit tubos Ø 8 mm y 6 mm ext. para bombas de transvase aceites.

PT Kit de tubos Ø 8 mm y 6 mm ext. para bombas de trasfega óleos.

OCP1/3

3/8" valve



OCP2/3

Two 3/8" valves



OCP1/6

1/2" valve



OCP2/6

Two 1/2" valves



TIPO TYPE	CODICE PART NUMBER	DESCRIZIONE DESCRIPTION	BOCCHIE PORTS
OCP1/3	165 030 00	1 valve tap for UP3-RK	3/8" BSPP
OCP2/3	165 031 00	2 valves tap for UP3-RK	3/8" BSPP
OCP1/6	165 032 00	1 valve tap for UP6-RK	1/2" BSPP
OCP2/6	165 033 00	2 valves tap for UP6-RK	1/2" BSPP

KB



Part No. 165 400 00

IT Kit cavi e pinze per batteria.

DE Kabelkit mit Batterieklemmen.

FR Kit de câbles et pinces de batterie.

EN Kit of cables and battery clips.

ES Kit de cables y clips de batería.

PT Kit de cabos e pinças de alimentação.

BF20



Part No.
165 005 10

BF25



Part No.
165 006 10

IT Filtro di fondo e portagomma per tubo ø20 o ø25 mm.

DE Fußfilter und Schlaucholive für ø20 mm oder ø25 mm Schlauch.

FR Filtre de fond et connexions pour tuyau de ø20 ou ø25 mm.

EN Bottom filter and hosefittings for tubing ø20 mm or ø 25 mm.

ES Filtro de fondo y conexiones para tubo ø20 o ø25 mm.

PT Filtro de fundo e ligações para tubo de ø20 ou ø25 mm.

UP14

page 11

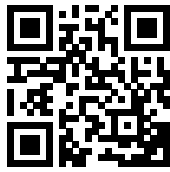

Scan the QR Code to watch the video

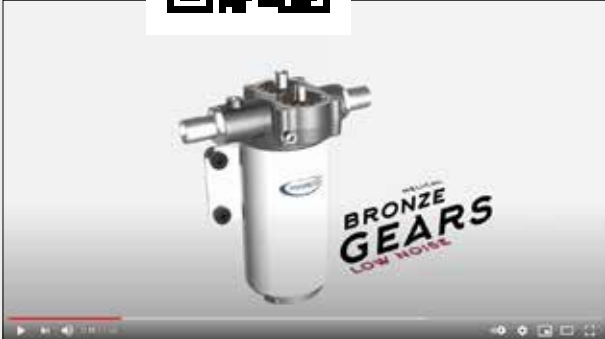

UP8-RE

page 23

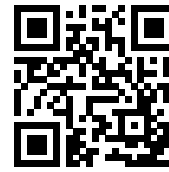

Scan the QR Code to watch the video



PRESSURE PUMPS

page 34

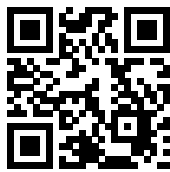

Scan the QR Code to watch the video



DP12/E

page 41

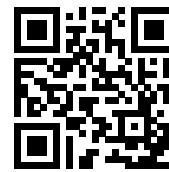

Scan the QR Code to watch the video



IMPELLER PUMPS

page 58



Scan the QR Code to watch the video



DC MOTOR AUTOMATIC LINE



Scan the QR Code to watch the video



COMPANY CERTIFICATIONS



ISO 9001

In quasi cinquant'anni di attività produttiva abbiamo sempre perseguito e mantenuto l'obiettivo qualità. Siamo determinati a costruire qualità dentro ogni cosa che facciamo. Vogliamo dare performance sempre migliori nei giusti tempi. Con una costante attenzione ai bisogni delle persone del nostro settore e coinvolgendo i nostri operatori in un'azione motivata e partecipe proponiamo prodotti, soluzioni e servizi innovativi mirando a superare le loro stesse aspettative. La nostra strategia aziendale si sviluppa attraverso un processo informativo sempre più controllato. Il nostro compito è quello di essere un partner affidabile per i nostri interlocutori, contribuire sempre più al loro successo attraverso la nostra organizzazione. La loro fiducia costituisce il nostro motivo ed è allo stesso tempo obiettivo di esistenza nel mercato internazionale.

In unserer fast 50 Jahren langen Aktivität haben wir die Qualität immer an die erste Stelle gesetzt. Wir sind entschlossen, diese Qualität in alle Teile zu integrieren, die wir entwickeln und herstellen. Wir streben danach, unser Leistungsvermögen innerhalb angemessener Zeitparameter ständig zu verbessern. Wir möchten innovative Produkte, Lösungen und Dienstleistungen anbieten, unter Berücksichtigung der Anforderungen und Bedürfnisse unserer Kunden, gepaart mit einem koordinierten und motivierten Handeln unserer Mitarbeiter, um die Kundenerwartungen zu übertreffen. Unsere Firmenstrategie entwickelt sich mit den digitalisierten und ständig besser kontrollierten Informations- und Produktionstechnologien. Unser Anliegen ist es, all unseren Kunden ein verlässlicher Partner zu sein und durch unsere Organisation zu deren Erfolg beizutragen. Das Vertrauen unserer Kunden ist unsere Antriebskraft und zugleich unser Ziel, um auf dem internationalen Markt zu bestehen.

Dans presque cinquante ans nous avons toujours poursuivi et maintenu l'objectif qualité. Nous sommes déterminés à construire qualité à l'intérieur de toute chose que nous faisons. Nous voulons donner performances de plus en plus meilleures dans les plus justes temps. Avec une constante attention aux besoins des personnes de notre secteur et impliquant nos opérateurs dans une action motivée et participée, nous proposons des produits, des solutions, et des services innovants en visant à surpasser leurs mêmes attentes. La stratégie de notre Maison se développe par un processus informatif de plus en plus contrôlé. Notre rôle est celui d'être un partenaire efficace et fidèle pour tous nos interlocuteurs et contribuer de plus en plus à leur succès à travers notre organisation. Leur confiance constitue notre but et en même temps l'objectif d'existence dans le marché international.

We have constantly strived for, and maintained the quality objective in almost fifty years of our manufacturing activity. We are determined to build quality into everything we make. We wish to constantly improve performance within adequate time parameters. Keeping in mind the needs of those who operate in our market sector, together with a coordinated and motivated action plan involving all our partners, we wish to offer innovative products, solutions and services while at the same time striving to exceed their expectations. Our company strategy is to evolve through a well controlled and informed business process. We aim to be a reliable partner to all our customers and to contribute increasingly to their success through our organization. Their trust constitutes our motive and at the same time our objective for existence in the international market.

En casi cincuenta años de actividad productiva hemos siempre perseguido y mantenido el objetivo calidad y estamos aún más decididos en "construir" calidad en cualquier cosa que vamos hacer. Queremos dar prestaciones siempre mejores en los tiempos adecuados. Con una atención constante a las necesidades de las personas de nuestro sector y envolviendo nuestros operadores en una acción motivada y participada, proponemos productos, soluciones y servicios innovadores, aspirando a superar sus mismas expectativas. Nuestra estrategia empresarial se desarrolla por medio de un proceso informativo muy avanzado y controlado. Nos proponemos ser un partner fiable para nuestros interlocutores y contribuir siempre más a su éxito por medio de nuestra organización. Su confianza constituye nuestro motivo y al mismo tiempo objetivo de existencia en el mercado internacional.

Em quase cinquenta anos de actividade produtiva sempre seguimos e mantivemos o objetivo da qualidade e estamos cada vez mais decididos a "construir" qualidade em qualquer coisa que façamos. Queremos dar sempre a melhor performance na hora certa. Com uma atenção constante nas necessidades das pessoas no nosso sector, e envolvendo os nossos colaboradores numa acção motivada e participante, propomos produtos, soluções e serviços inovadores, aspirando ultrapassar as suas expectativas. A nossa estratégia empresarial desenvolve-se por meio dum processo informativo muito avançado e controlado. Ambicionamos ser um parceiro fiável para nossos interlocutores e contribuir cada vez mais para o seu êxito por intermédio da nossa organização. A sua confiança constitui o nosso motivo e ao mesmo tempo o objetivo da nossa existência no mercado internacional.



ISO 14001

Alla base della vita c'è il rispetto di essa. Trattare le risorse della natura con responsabilità è diventato un motivo dominante per chi, come noi, vuole offrire un futuro all'ambiente. La qualità della vita di tutti i giorni è il presupposto per l'esistenza di un futuro affrontabile. Materiali riciclabili, prodotti a ridotto consumo di energia, procedimenti produttivi ecologici, operatori formati e informati contribuiscono a salvaguardare passo dopo passo l'ambiente come risultato di una scelta attenta e consapevole.

Ausgangspunkt des Lebens ist der Respekt für dasselbe. Die natürlichen Ressourcen müssen verantwortungsbewußt benutzt werden; das ist das Leitmotiv für all diejenigen, die, wie wir, der Umwelt eine Zukunft bieten wollen. Die Qualität des Alltags ist die Voraussetzung für eine akzeptable Zukunft. Material zur Wiederverwertung, Produkte, die ein Minimum an Energie verbrauchen, ökologische Produktionsverfahren, sowie ausgebildetes und höchstinformiertes Personal tragen dazu bei, Schritt für Schritt die Umwelt zu respektieren und sie mit verantwortungsbewußten Entscheidungen zu retten.

À la base de la vie il y a le respect. Traiter les ressources de la nature avec responsabilité est devenu un motif dominant pour qui, comme nous, veut offrir un futur à l'environnement. La qualité de la vie de tous les jours est le fondement de l'existence d'un futur abordable. Matériels recyclés, produits à consommation d'énergie réduite, procédés de production écologiques, opérateurs formés et informés contribuent, pas à pas, à sauvegarder l'environnement comme résultat d'un choix de conscience.

Respect for life remains at the essence of life itself. Managing nature's resources with responsibility has become a dominant motive for those who, like us, wish to contribute to the future of the environment. Everyday quality of life is a basic requirement for the existence of a promising future. Recyclable materials, reduced energy consumption products, ecological production processes, well-trained and informed workers, all contribute to protecting the environment, step by step, as a result of responsible and accurate choices made all along.

El respeto a la vida es la esencia de la vida misma. Tratar los recursos de la naturaleza con cuidado se ha hecho un motivo dominante para quien, como nosotros, quiere garantizar un futuro al ambiente. La calidad de la vida cotidiana es la premisa para la existencia de un futuro posible. Materiales reciclables, productos a bajo consumo de energía, procesos productivos ecológicos, operadores formados e informados contribuyen a salvaguardar paso a paso el medio ambiente como logro de una elección atenta y consciente.

O respeito pela vida é a essência da própria vida. Tratar os recursos da natureza com responsabilidade tornou-se num motivo dominante para quem, como nós, quer garantir um futuro ao ambiente. A qualidade da vida diária é a premissa para a existência dum futuro promissor. Materiais recicláveis, produtos de baixo consumo de energia, processos produtivos ecológicos, operadores formados e informados contribuem para salvaguardar passo a passo o meio ambiente, como resultado duma escolha atenta e consciente.

Garanzia

- 1) Il periodo di garanzia è di 2 anni dalla data d'acquisto come risulta dalla relativa fattura.
- 2) Nel caso la fattura non fosse disponibile, il periodo di garanzia di 2 anni sarà calcolato dalla data di fabbricazione.
- 3) La garanzia decade e s'intende nulla in caso d'utilizzazione non corretta o nel caso venissero ignorate le istruzioni contenute nei manuali.
- 4) La garanzia copre solamente i difetti di fabbricazione.
- 5) La garanzia non copre i costi connessi di installazione e smontaggio.
- 6) I costi di trasporto sono rimborsabili solo nel caso in cui la garanzia sia stata debitamente riconosciuta e accettata da Marco S.p.A. Il rimborso sarà limitato ai costi di spedizione dal magazzino di Marco S.p.A. alla sede del cliente.
- 7) Nessuna nota di credito o reso saranno effettuati prima di un test eseguito dal controllo di qualità di Marco S.p.A. che dichiari difettoso il prodotto.

La società MARCO non accetterà nessun reso senza previa accettazione e accordo dell'ufficio commerciale.

Garantie

- 1) Die Garantie von 2 Jahren beginnt mit dem Einkaufsdatum d.h. Datum unserer Rechnung an den Kunden.
- 2) Für den Fall, dass die Rechnung nicht vorliegt beginnt die Garantie von 2 Jahren ab unserem Produktionsdatum.
- 3) Die Garantie verfällt bei nicht korrektem Einsatz des Produktes, oder bei Ignorierung der Gebrauchsanweisungen.
- 4) Die Garantie wird nur für Produktionsfehler akzeptiert
- 5) Die Garantie beinhaltet nicht die Kosten für Installation oder Abmontierungen
- 6) Die Transportkosten werden von der Firma MARCO S.p.A. nur in dem Fall getragen, wo der Garantiefall akzeptiert wurde. Diese Kosten beinhalten den Transport ab dem Werk der Firma MARCO bis zum Firmensitz des Kunden.
- 7) Es wird keine Gutschrift erstellt und kein Austausch gestattet bis die erfolgten Tests der Qualitätskontrolle von der MARCO S.p.A. einen effektiven Produktionsfehler bewiesen haben.

Die Firma MARCO akzeptiert keine Rücksendungen ohne vorherige Absprache mit dem Verkaufsbüro.

Garantie

- 1) La période de garantie est de 2 ans de la date d'achat qui est indiquée sur la facture correspondante.
- 2) Le cas où la facture ne soit pas disponible la période de garantie de 2 ans sera calculée de la date de fabrication.
- 3) La garantie déchoit et est considérée annulée en cas d'utilisation incorrecte ou en cas les instructions contenues dans le manuel d'instructions soient ignorées.
- 4) La garantie couvre seulement les défauts de fabrication.
- 5) La garantie ne couvre pas les coûts liés à l'installation et démontage.
- 6) Les frais de transport sont remboursables seulement le cas où la garantie est dument reconnue et acceptée par MARCO S.p.A. Ces coûts seront limités aux frais d'expédition entre le magasin de Marco S.p.A. et l'adresse du client.
- 7) Aucune note de crédit ou de remplacement sera émise avant que le produit réclamé soit examiné par le Département de Contrôle de Qualité de MARCO S.p.A. qui est le seul qui peut déclarer défectueux le produit.

La maison MARCO n'acceptera pas aucun retour de marchandise sans préalable accord et acceptation du bureau commerciale.

Warranty

- 1) The Warranty period is 2 years from date of purchase on production of the appropriate sales invoice.
- 2) Should the original sales invoice not be available, then the 2 year warranty period will be valid from date of production.
- 3) The Warranty becomes null and void in the case of incorrect utilization or disregard of the instructions contained within manuals.
- 4) The Warranty only covers original production defects.
- 5) The Warranty does not cover any related installation costs involved.
- 6) Transport costs are refundable only in the case where warranty has been duly recognized and accepted by Marco Spa. These costs will be limited to the actual shipment costs between Marco Spa warehouse and the client's delivery address.
- 7) No credit notes or replacement items will be issued prior to the receipt and proper testing of any Marco goods that are deemed faulty.

The company MARCO will not accept any returned goods without prior agreement and approval of the sales department.

Garantía

- 1) El periodo de garantía es de 2 años de la fecha de compra, como resulta en la factura relativa.
- 2) En el caso que la factura no sea disponible, el periodo de garantía de 2 años será calculado de la fecha de producción.
- 3) La garantía vence y se considera nula en caso de uso incorrecto o en caso sean desatendidas las instrucciones contenidas en los manuales.
- 4) La garantía cubre solamente los defectos de fabricación.
- 5) La garantía no cubre los costes envueltos de instalación y desmontaje.
- 6) Los costes de transporte son reembolsables sólo en el caso che la garantía haya sido reconocida y aceptada por Marco S.p.A. Estos costes serán limitados al los costes de envío desde el almacén de Marco S.p.A. y la sede del cliente.
- 7) Ninguna nota de crédito o devolución será hecha antes de un test realizado por el controle de calidad de Marco S.p.A que declare el producto defectuoso.

La firma MARCO no podrá aceptar devoluciones de mercadería sin previo acuerdo y aprobación del departamento comercial.

Garantia

- 1) O período de garantia é de 2 anos da data de compra, como indicado na factura relativa.
- 2) Caso a factura não esteja disponível, o período de garantia de 2 anos será calculado a partir da data de fabrico.
- 3) A garantia caduca e é considerada nula no caso de incorrecta utilização ou no caso em que sejam ignoradas as instruções contidas nos manuais.
- 4) A garantia cobre só os defeitos de fabricação.
- 5) A garantia não cobre custos de instalação e/ou desmontagem.
- 6) Os custos de transporte são reembolsáveis só no caso em que a garantia seja reconhecida e aceite pela Marco S.p.A. O reembolso será limitado aos custos de envio desde o armazém da Marco S.p.A. até à sede do cliente.
- 7) Nenhuma nota de crédito ou devolução será feita antes dum teste efectuado pelo controle de qualidade da Marco S.p.A, que declare o produto defeituoso.

A firma MARCO não poderá aceitar devoluções de mercadoria sem prévio acordo e aprovação pelo departamento comercial.

RETURN PROCEDURE

PROCEDURA RESI

Prima di restituire un prodotto alla MARCO s.p.a. contattare l'assistenza clienti per ricevere un numero di autorizzazione. Questo numero va riportato sull'esterno del pacco di spedizione. Inserire nel pacco una nota con la spiegazione del motivo della restituzione e indicare anche il numero di autorizzazione, il vostro nome, indirizzo e numero di telefono.

RÜCKGABEVERFAHREN

Vor jeder Rücksendung eines Produktes an Marco s.p.a. bitten wir Sie uns anzurufen, damit wir Ihnen eine genehmigte Vorgangsnummer zuteilen. Diese Vorgangsnummer muss auf der Außenseite des Versand-Pakets lesbar sein. Legen Sie eine Fehlerbeschreibung in das Paket mit einer erneuten Nennung der Vorgangsnummer. Fügen Sie Ihren Namen, Anschrift und Telefonnummer bei.

PROCÉDURE DE RETOUR

Avant de renvoyer un produit à la maison MARCO S.P.A. il faut contacter notre service d'assistance aux clients pour avoir le numéro d'autorisation au retour. Ce numéro devra être mentionné à l'extérieur du colis d'expédition. En même temps insérer dans le colis une note expliquant la raison du retour et indiquant le numéro d'autorisation, Votre nom, adresse et numéro de téléphone.

RETURN PROCEDURE

Prior to returning any product to MARCO s.p.a. call customer service for an authorization number. This number must be written on the outside of the shipping package. Place a note inside the package explaining the reason of the return and reporting the authorization number. Include your name, address and phone number.

PROCEDURA DE DEVOLUCIONES

Antes de devolver un producto a la MARCO s.p.a., contactar el servicio clientes para recibir un numero de autorización. Este numero tiene que ser escrito al exterior del paquete de expedición. Insertar en el paquete una nota con la explicación del motivo de la devolución, indicando también el numero de autorización, su nombre, dirección y numero de teléfono.

PROCESSO DE DEVOLUÇÕES

Antes de devolver um produto à MARCO s.p.a., contactar o serviço clientes para receber um numero de autorização. Este numero tem que ser escrito no exterior do pacote de expedição. Inserir no pacote uma nota com a explicação do motivo da devolução, indicando também o numero de autorização, seu nome, endereço e numero de telefone.



MATE USA was developed thanks to the partnership between **Marco** and **Tessilmare**, two of the world leading high quality Italian manufacturers.

Marco produces and sells one of the most comprehensive ranges of pumps and horns available worldwide. Founded in Italy in 1970, they supply major international OEM and aftermarket players in the marine, automotive, industrial and agricultural sectors using the most advanced technology and complying with the highest International Quality Standards.

Tessilmare is renowned for providing some of the most affordable, durable, and attractive ranges of rub rails anywhere in the world. Founded in Italy in 1947, you know you're getting a high-quality product, with a precision finish.

The international experience of both Italian companies is the base on which MATE USA built their ambitious distribution plan.

Through market research and global innovation, MATE USA is constantly growing and expanding to meet global demand.

MATE USA understands what it takes to be successful in a high-speed, online, global marketplace.

The company has been providing top of the line, affordable and durable products throughout the United States for almost 10 years.

As part of its ongoing commitment to excellence and product innovation, MATE USA has constantly been striving to upgrade its services and products. MATE USA has an ever-increasing number of partners and distributors across North America. They are also attending over 25 trade shows and exhibition shows this year.

MATE USA is structured for daily deliveries.

That means that when you order your products from MATE USA, they'll be on their way to you within 24-hours!



MATE USA, LLC

3251-A S.W. 13th Dr. - Deerfield Beach, FL 33442

Phone 954-463-5757 • Fax 954-463-5635

www.mate-usa.com

info@mate-usa.com

orders@mate-usa.com

SELECTION GUIDE

Tipo Type	12V	24V	30V	Portata l/min Flow Rate l/min	Pressione bar Pressure bar	Diesel	Olio Oil	Acqua e Soluzioni Water and Fluids	Ingranaggi in PEEK PEEK Gears	Alta Pressione High Pressure	Electroniche Electronic	Controllo Remoto Remote Control	Reversibile Reversible	Kit	Acciaio Inox Stainless Steel	Pagina Page
UP2	●	●		10	1,5	●						●				9
UP3	●	●		15	2	●						●				9
UP3-CK	●	●		15	2	●						●	●			9
UP3-S	●	●		15	2	●						●				10
UP3-R	●	●		15	2	●						●				10
UP6	●	●		26	2	●						●				10
UP12	●	●		36	2	●						●				11
UP14	●	●		46	2	●						●				11
UP8	●	●		10	4	●				●		●				11
UP9	●	●		12	5	●				●		●				12
UP9-HD	●	●		12	5	●				●		●				12
UP10	●	●		18	7	●				●		●				12
UP10-HD	●	●		18	7	●				●		●				13
UP3/AC			●	10	6	●				●						13
UP6/AC			●	28	5	●				●						14
UP14/AC			●	44	4	●				●						14
VP45-N	●	●		45	1,2	●										16
VP45	●	●		45	1,2	●							●			16
VP45-S	●	●		45	1,2	●										16
VP45A-S	●	●		45	1,2	●										17
VP45-K	●	●		45	1,2	●								●		17
VP45/AC			●	35	1	●										17
UP2/E-BR	●	●		10	2	●	●			●	●					19
UP3/E-BR	●	●		15	2,5	●	●			●	●					19
UP6/E-BR	●	●		26	2,5	●	●			●	●					19
UP12/E-LOBR	●	●		26	3	●	●			●	●					20
UP12/E-BR	●	●		36	2,5	●	●			●	●					20
UP14/E-BR	●	●		46	2,5	●	●			●	●					20
UP8/E-BR	●	●		10	3,5	●	●			●	●	●				21
UP9/E-BR	●	●		12	4,5	●	●			●	●	●				21
UP10/E-BR	●	●		18	6	●	●			●	●	●				21
UP8-RE	●	●		10	3,5	●	●			●	●	●				23
UP3-RK	●	●		15	2	●	●			●	●	●				23
UP6-RK	●	●		26	2	●	●			●	●	●				23
UP2/OIL	●	●		3,3	1,5		●					●				25
UP3/OIL	●	●		5,5	2		●					●				25
UP3/OIL-R	●	●		5,5	2		●					●				25
OCK1	●	●		5,5	2		●					●	●			26
OCK1-R	●	●		5,5	2		●					●	●			26
UP6/OIL	●	●		8	5		●			●		●				26
UP12/OIL	●	●		15	3		●					●				27
UP12-LO	●	●		22	3		●					●				27
UP12-LOCK	●	●		22	3		●					●	●			27
UP14/OIL	●	●		18,3	2		●					●				28
NEW UP1-J/OIL	●	●		15	1		●					●				28
NEW UP6/OIL-AC			●	14	5		●			●						29
NEW UP14/OIL-AC			●	21	4		●			●						29

SELECTION GUIDE

Tipo Type	12V	24V	230V	Portata l/min Flow Rate l/min	Pressione bar Pressure bar	Diesel	Oil Oil	Acqua e Soluzioni Water and Fluids	Ingranaggi in PEEK PEEK Gears	Alta Pressione High Pressure	Elettroniche Electronic	Controllo Remoto Remote Control	Reversibile Reversible	Kit	Acciaio Inox Stainless Steel	Pagina Page
OCK8-E	●	●		10	3,5	●	●			●	●	●	●			30
OCK1-E	●	●		15	2	●	●				●		●	●		30
OCS3/E	●	●		10	2		●				●		●			31
OCS5/E	●	●		10	2		●				●		●			31
OCS6/E	●	●		15	2		●				●		●			31
OCS9/E	●	●	●	15	2		●				●		●			31
UP2/E	●	●		10	2			●			●					35
UP3/E	●	●		15	2,5			●	■		●	●				35
UP6/E	●	●		26	2,5			●	■		●	●				35
UP6/E H.P.		●		26	3,5			●	■	●	●	●				35
UP12/E	●	●		36	2,5			●	■		●	●				36
UP12/E H.P.		●		36	3,5			●	■	●	●	●				36
UP12/E-LO	●	●		26	3			●	■		●	●				36
UP14/E	●	●		46	2,5			●			●	●				36
UP14/E H.P.		●		46	3,5			●		●	●	●				36
UP6/E-DX	●	●		52	2,5			●	■		●	●				37
UP6/E-DX H.P.		●		52	3,5			●	■	●	●	●				37
UP66/E-DX	●	●		66	2,5			●	■		●	●				37
UP66/E-DX H.P.		●		66	3,5			●	■	●	●	●				37
UP12/E-DX		●		72	3,5			●	■	●	●	●				37
UP14/E-DX		●		92	3,5			●		●	●	●				38
UP8/E	●	●		10	3,5			●	■	●	●	●				38
UP9/E	●	●		12	4,5			●	■	●	●	●				38
UP10/E	●	●		18	6			●	■	●	●	●				39
DP3/E	●	●		14	3			●	■		●			●		41
DP9/E	●	●		12	4,5			●	■	●	●			●		41
DP12/E	●	●		15	6			●	■	●	●			●		41
SP2	●	●		10	2			●			●			●		42
TK1/2	●	●		10	2			●			●			●		42
TK2/2	●	●		10	2			●			●			●		42
TK1-SP	●	●		10	2			●			●			●		43
TK2-SP	●	●		10	2			●			●			●		43
TK1-SP3	●	●		15	2,5			●	■		●			●		43
UP2-P	●	●		10	1,5			●				●				45
UP2-PV	●	●		10	1,5			●								45
UP3-P	●	●		15	2			●	■			●				45
UP3-PV	●	●		15	2			●	■							46
UPX	●	●		15	2			●	■			●			●	46
UPX-C	●	●		15	2			●	■			●			●	46
UP6-P	●	●		26	2			●	■			●				47
UP6-PV	●	●		26	2			●	■							47
UP12-P	●	●		36	2			●	■			●				47
UP12-PV	●	●		36	2			●	■							48
UP14-P	●	●		46	2			●				●				48
UP14-PV	●	●		46	2			●								48
UP8-P	●	●		10	4			●	■	●		●				49
UP8-XC	●	●		10	4			●	■	●		●			●	49
UP9-P	●	●		12	5			●	■	●		●				49

Tipo Type	12V	24V	230V	Portata l/min Flow Rate l/min	Pressione bar Pressure bar	Diesel	Oil Oil	Acqua e Soluzioni Water and Fluids	Ingranaggi in PEEK PEEK Gears	Alta Pressione High Pressure	Electroniche Electronic	Controllo Remoto Remote Control	Reversibile Reversible	Kit	Acciaio Inox Stainless Steel	Pagina Page
UP9-XC	●	●		12	5			●	●	●					●	50
UP9-XA	●	●		12	5			●	●	●					●	50
UP9-XA/DM	●	●		12	5			●	●	●					●	50
UP10-P	●	●		18	7			●	●	●						51
UP10-XC	●	●		18	7			●	●	●					●	51
UP10-XA	●	●		18	7			●	●	●					●	51
UP10-XA/DM	●	●		18	7			●	●	●					●	52
UPX/AC			●	10	6			●	●	●					●	52
UPX-C/AC			●	10	6			●	●	●					●	52
UP2/A	●	●		10	1,5			●								53
UP3/A	●	●		15	2,5			●	●							53
UP6/A	●	●		26	2			●	●							54
UP9/A	●	●		12	4			●	●	●						54
UP12/A		●		36	2,5			●	●							54
UP12/A-V5		●		36	2,5			●	●							55
UP12/A-V20		●		36	2,5			●	●							55
UP6/A-AC			●	28	2,5			●	●							56
DP3	●	●		14	3			●	●					●		57
DP9	●	●		12	4			●	●	●				●		57
DP12	●	●		15	5			●	●	●				●		57
UP1-J	●	●		28	1			●					●			59
UP1-JS	●	●		28	1			●					●			59
UP1-JR	●	●		28	1			●					●			59
UP1	●	●		35	1,2			●					●			60
UP1-M	●	●		45	1,5			●					●			60
UP1-B	●	●		45	1,5			●					●			60
UP1/AC			●	30	1			●								61
UP500	●	●		32	0,4			●								63
UP1000	●	●		63	0,4			●								63
UP1500	●	●		95	0,4			●								63
UP2000	●	●		126	0,5			●								64
UP3700		●		233	0,5			●								64

Prodotti e caratteristiche tecniche aggiornate a Luglio 2021.

La MARCO S.p.A. si riserva il diritto di modificare in qualsiasi momento e senza preavviso le caratteristiche tecniche dei prodotti contenuti in questo catalogo. Il cliente precisi in fase d'offerta/ordine le caratteristiche tecniche richieste.

Neuester Stand der Produkte und technische Eigenschaften: Juli 2021. Die Firma MARCO S.p.A. behält sich das Recht vor in jedem Moment und ohne vorherigem Hinweis, die technischen Daten, der in diesem Katalog angegebenen Produkte, zu verändern. Der Kunde ist gebeten sich bei Anfrage/Bestellung nach den aktuellen Daten zu erkundigen.

Les produits et les caractéristiques techniques sont mis à jour à juillet 2021. La maison MARCO S.p.A. se réserve le droit de modifier à n'importe quel moment y sans préavis les caractéristiques techniques des produits illustrés dans ce catalogue. Le client doit préciser lors de la demande d'offre ou de la commande les caractéristiques techniques demandées.

Products and technical details are updated as of July 2021.

The Company MARCO S.p.A. reserves the right to alter the technical details of the products illustrated in this catalogue at any time whatsoever, without any prior notice. Customers must specify the technical specifications required when enquiring or ordering the products.

Los productos y los detalles técnicos son actualizados al mes de julio 2021. La Sociedad MARCO S.p.A. se reserva el derecho de alterar los detalles técnicos de los productos ilustrados en este catálogo en cualquier momento y sin preaviso. Los clientes tienen que precisar en los pedidos de cotización o sea en las ordenes los detalles técnicos requeridos.

Produtos e características técnicas actualizados em Julho 2021. A Firma MARCO S.p.A. reservase o direito de modificar os detalhes técnicos dos produtos ilustrados no catálogo em qualquer momento e sem préaviso. Os clientes tem que precisar quando da solicitação de pedido ou da encomenda os detalhes técnicos requeridos.

MARCO[®]

Via Mameli, 10
25014 Castenedolo
Brescia - Italy

Tel. +39 030 2134.1
Fax +39 030 2134.300
E-mail: info@marco.it

www.marco.it



VENDITE EXPORT

E-mail: export@marco.it
Tel. +39 030 2134.362
Fax +39 030 2134.302

VENDITE ITALIA

E-mail: vendite@marco.it
Tel. +39 030 2134.361
Fax +39 030 2134.301



MATE USA, LLC

3251-A S.W. 13th Dr.
Deerfield Beach
FL 33442

Phone 954-463-5757
Fax 954-463-5635

www.mate-usa.com
info@mate-usa.com
orders@mate-usa.com

U.S. Branch

MATE
USA The logo for MATE USA, featuring the word "MATE" in a large, bold, blue font, with "USA" in a smaller, red font below it, and a stylized graphic of a globe or sunburst to the right.