



FLEXIBLE ACOUSTIC NOISE BARRIER

WAVEBAR AND QUADZERO RANGE



BUILDING - INDUSTRIAL - TRANSPORT - MARINE - OIL & GAS



SOUNDPROOFING SOLUTIONS FOR ALL INDUSTRIES
pyroteknc.com

Pyrotek.



MASS LOADED VINYL FOR ALL INDUSTRIES

The mass loaded vinyl (MLV) range has been uniquely developed by Pyrotek's world class engineering team. Offering superior acoustic transmission loss - Wavebar® and Quadzero™ are flexible reinforced noise barrier solutions that meet global market requirements in all industries including building, industrial, transport, marine and oil & gas.

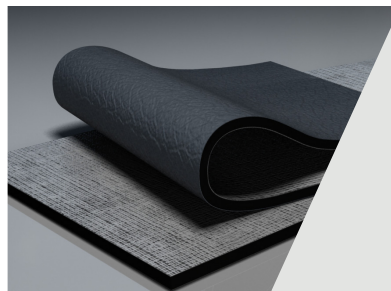

Wavebar® is a reinforced MLV noise barrier designed by Pyrotek to meet market requirements and effectively reduce noise transmission. Due to its flexible and tear resistant properties, Wavebar is suitable for various applications across all industries such as building, commercial, industrial and transport. Wavebar will help improve performance of a lightweight partition at critical frequencies.

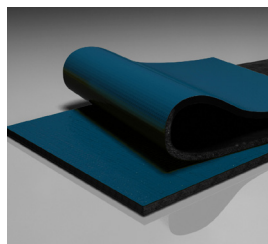

Wavebar® NC

Wavebar® NC is a tear resistant noise barrier curtain with high tensile strength. The tarpaulin base fabric facing is used to withstand tough weather conditions in addition to being UV resistant. Able to withstand exposure to most chemicals and solvents, Wavebar NC is easy to hang or drape in long lengths – being the ideal choice for outdoor use, oil and gas industries and construction sites. It can also be combined with absorption materials, offering versatility in challenging noise environments. The tarpaulin base fabric facing is available in various colours.

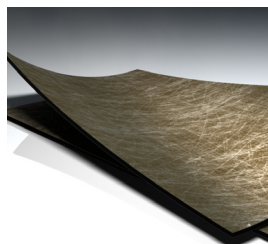

Wavebar® dBX

Wavebar® dBX is the latest alternative in noise barrier technology manufactured from thermoplastic recycled polymers. A self-extinguishing and low smoke emission noise barrier, Wavebar® dBX provides high-performance acoustic insulation that can be vacuum formed and easily moulded. This product is 100% recyclable and recommended for transport, building and industrial applications due to its strong characteristics.

Our Wavebar® and Quadzero™ range perform an important role as high-performance barriers where noise transmission issues need to be addressed. Typically stiff lightweight panels such as plasterboard, drywall, plywood and hollow core walls have a coincidence dip. A coincidence dip is the frequency at which the stiff panel vibrates in unison with the frequency of sound pressure waves. The frequency of the coincidence dip is dependent on the material's stiffness and internal damping properties causing a degradation in transmission loss. The Wavebar® and Quadzero™ range will eliminate the impact of the coincidence dip when installed in a structure, rendering it as a highly effective noise barrier.

SUPERIOR ACOUSTIC TRANSMISSION LOSS

BETTER FLEXIBILITY EASY TO INSTALL

Quadzero™ is a flame resistant foil faced MLV offering superior acoustic transmission loss with high flame retardant properties. The reflective foil facing provides a low spread of flame surface covering for areas where higher fire specifications are required. Additionally, the dense, thin and strong physical characteristics make Quadzero suitable for building, industrial and transport.

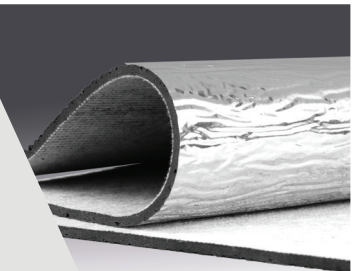

Quadzero™ NL is a foil faced barrier that is formulated to achieve the highest fire rating as an acoustic surface covering. It is durable, flexible and tear resistant, with a strong base fabric. This product offers optimum noise transmission loss with fire testing results that complies with international marine and rail standards. Quadzero NL is suitable for marine and rail carriages in walls, ceilings and under floor insulation, as it contains no ozone depleting substances, lead, unrefined oils or bitumen.

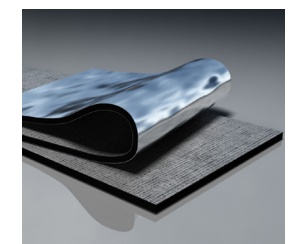

Quadzero™ NL

Quadzero™ dBX is a MLV laminated with reinforced aluminium foil, manufactured from thermoplastic recycled polymers that exhibits superior transmission loss. Meeting international standards for rail, transport and marine, Quadzero dBX has high fire resistant properties, a low spread of flame surface and low smoke development. This product is suitable for marine, transport and rail applications. Quadzero™ dBX is 100% recyclable.

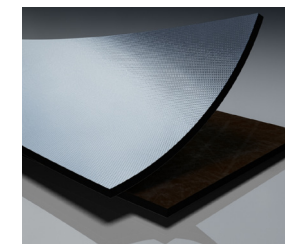

Quadzero™ dBX

Quadzero™ MVT is a foil-faced, mass-loaded vinyl developed to meet moisture vapor transmission (MVT) resistance in liquefied natural gas (LNG) and cryogenic pipelines. It also serves as an acoustic barrier to assist in reducing noise. As an acoustic solution, Quadzero™ MVT reduces the impact of unwanted sound, offering a 2-in-1 barrier product to not only combat noise, but also vapor transmission.

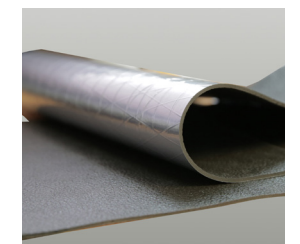

Quadzero™ MVT

IDEAL NOISE BARRIER SOLUTIONS FOR ALL MARKETS

Wavebar® is weather resistant, contains no ozone depleting substances and complies with International standards for Volatile Organic Compound (VOC) emissions.

Building - Commercial

Wavebar® and Wavebar® dBX fitted in the plenum space above suspended ceilings and partition walls to avoid flanking noise.

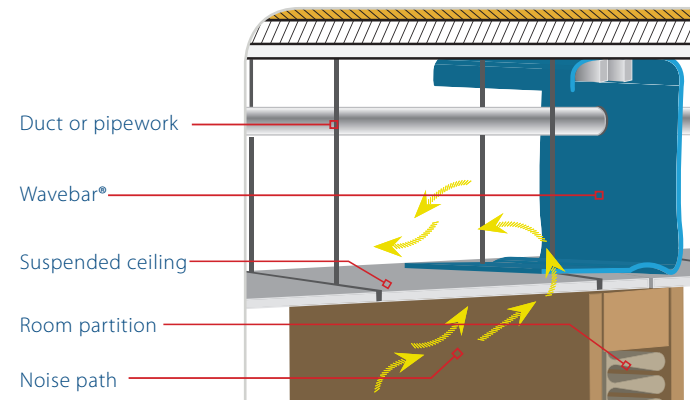

Building - Residential

Quadzero™ is suitable for ceiling cavities due to its reflective and low spread of flame surface covering.

Wavebar® fitted between plasterboard walls for greater transmission loss. Improves performance at critical frequencies generated from urban and environmental noise impact.

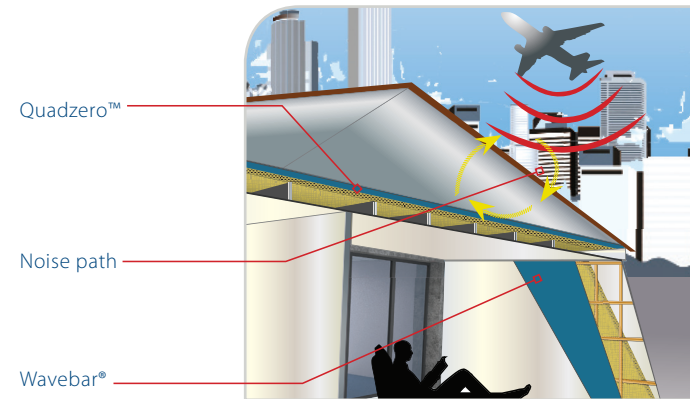

Transport

Quadzero™ NL and Quadzero™ dBX will effectively control sound transfer from external track, rail or engine noise into cabins and carriages. This durable product can be used without impacting carriage safety providing additional comfort to passengers.

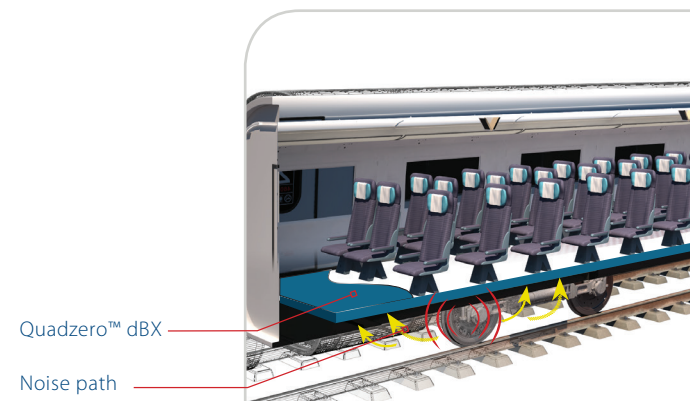

Marine

Quadzero™ NL and Quadzero™ dBX can be installed in the wall linings, deckheads and bulkheads of marine vessels to reduce sound transmission emitting from the vessel engine room.

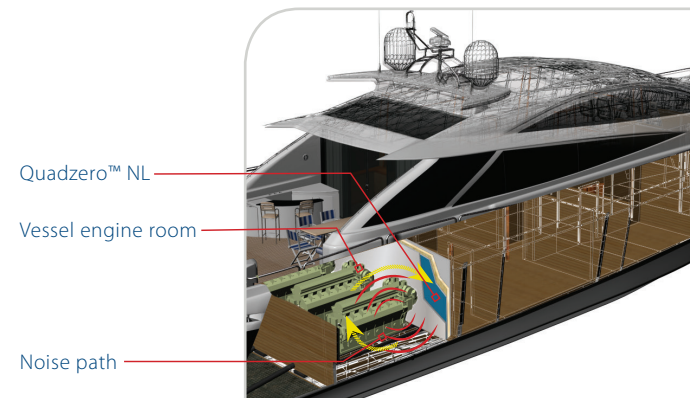

Industrial - Outdoor

Wavebar® NC can be conveniently draped over fencing as an acoustic barrier to reduce noise transmission around construction sites, building sites and mobile equipment.



Industrial - Indoor

Wavebar® NC can be easily fabricated and sewn to make custom enclosures to reduce noise transfer from generator sets, plant rooms, printing machines and other heavy equipment.

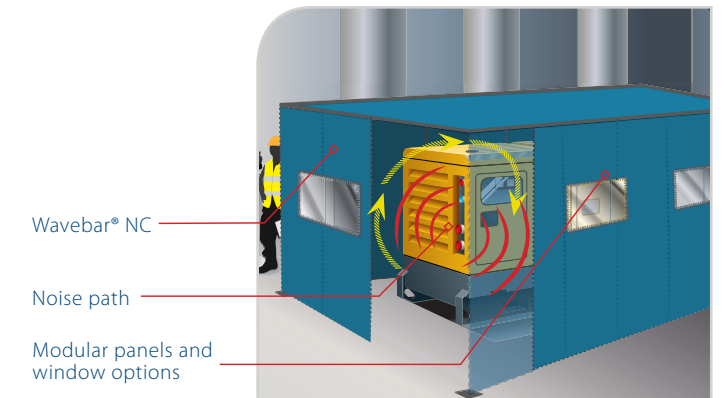
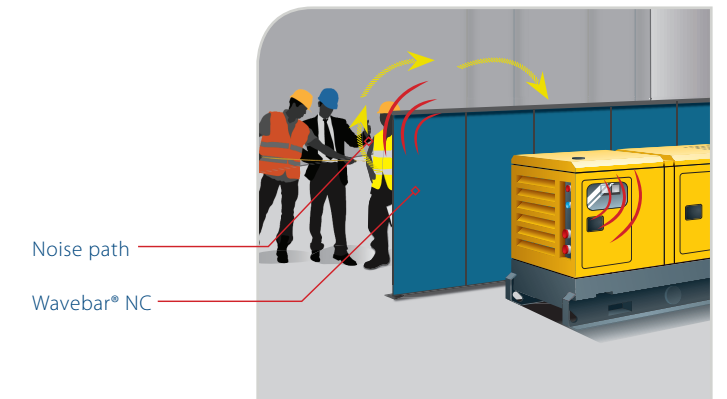

LNG Pipes

Lagged around pipes, Wavebar® & Quadzero™ MVT are important for LNG (Liquid Natural Gas) pipe applications to prevent noise breakout.

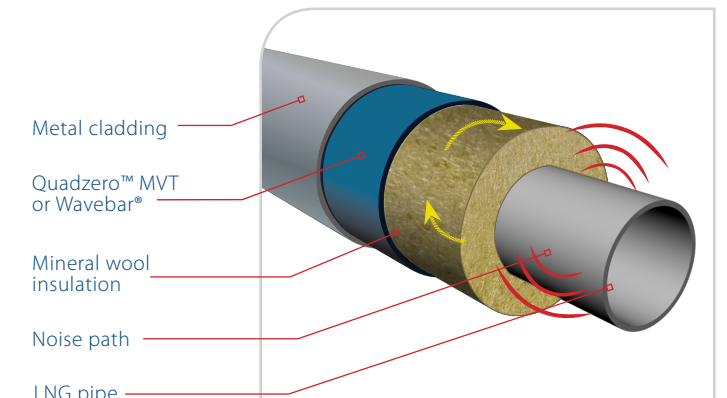

Wavebar® complies to the ISO 15665 (Group 2 Pipe size) test method.



APPLICATIONS

Suited across a variety of applications, the mass loaded vinyl range offers superior acoustic transmission loss benefiting the following areas:

PRODUCT	TYPICAL AREAS OF USE
Wavebar®	<ul style="list-style-type: none"> Home theatre and office partitions Inside cavities, over lightweight walls and ceilings Between the plenum chamber of a slab, the roof and adjoining partition walls
Wavebar® NC	<ul style="list-style-type: none"> Noise curtain for indoor/outdoor industrial and construction sites Enclosures for industrial equipment e.g. generators, engine rooms, punch presses
Wavebar® dBX	<ul style="list-style-type: none"> Automotive cabin Heavy transport and machinery Acoustic doors
Quadzero™	<ul style="list-style-type: none"> Building construction Industrial cladding Roof cavities
Quadzero™ NL	<ul style="list-style-type: none"> Train and tram carriages Marine deckheads and bulkheads Marine engine room
Quadzero™ dBX	<ul style="list-style-type: none"> Train and tram carriages Marine engine room deck Inside cavities or over lightweight walls, ceilings and floor constructions
Quadzero™ MVT	<ul style="list-style-type: none"> Liquefied natural gas (LNG) and cryogenic pipes Valves and fan casings Compressor jackets



TESTED TO A RANGE OF GLOBAL FIRE STANDARDS

FEATURES	BENEFITS
<ul style="list-style-type: none"> Flexible and easy to install Isolate cavities, over lightweight walls and ceiling constructions Reinforced fabric strength 	<ul style="list-style-type: none"> Reduces noise transfer through lightweight partition walls and ceilings Reduce cross-talk noise and ensure privacy Longevity
<ul style="list-style-type: none"> Can be designed as a partial or complete enclosure around noise sources Manufacturing options with stainless steel eyelets and hook-and-loop fasteners Portable acoustic curtain easily draped over fencing 	<ul style="list-style-type: none"> Curtains are durable and address environmental noise impact Customised for unique purposes and difficult sites Reduce noise transmission around construction areas and mobile equipment on site
<ul style="list-style-type: none"> Low smoke emission - contains no ozone depleting substances Can be easily moulded into linings Thermoplastic properties 	<ul style="list-style-type: none"> Safe and self-extinguishes in heavy vehicle, road/engine bay 100% recyclable Rail carriage will hold its integrity for longer in case of emergency
<ul style="list-style-type: none"> Fire resistant foil properties Resistant to water, oil and natural weather conditions Reflective foil faced surface 	<ul style="list-style-type: none"> Complies to international building standards Joins are easily taped for quick installation Free from lead, odour producing oils and bitumen
<ul style="list-style-type: none"> Highest flame retardant properties Self-extinguishes upon removal of flame Aluminium foil faced surface 	<ul style="list-style-type: none"> Suitable for use in high risk areas including marine & offshore Meets international marine & rail standards Used where high fire standards are required
<ul style="list-style-type: none"> Flame retardant properties Reinforced aluminium facing Suitable for use where thermoplastic materials are required 	<ul style="list-style-type: none"> Durable with low spread of flame 100% recyclable Aluminium faced materials can be easily joined using foil tape
<ul style="list-style-type: none"> Low vapor permeability Tear resistant with high tensile strength Suitable for use with LNG pipes 	<ul style="list-style-type: none"> 2-in-1 solution: vapor barrier and noise barrier Blocks moisture entry - maintaining thermal properties Flexibility for easy install



pyroteknc.com



With over 40 years of noise control experience, Pyrotek® is a well trusted name for performance improving technical solutions. We offer global resources with dependable local support.



80+ locations in 30+ countries

- Six research and development centres
- Five engineering centres
- Global headquarters in Spokane, Washington, USA

pyroteknc.com

CONTACT DETAILS

for further information or to see your local office
please visit our website

Pyrotek endorse forest sustainability and the preservation of natural environment. We procure the highest quality materials from suppliers who hold FSC (Forest Stewardship Council) Certification and PEFC (Programme for the Endorsement of Forestry Certification) amongst other certification programmes.

Caveats: Specifications are subject to change without notice. The data in this document are typical of average values based on tests by independent laboratories or by the manufacturer and are indicative only. Materials must be tested under intended service conditions to determine their suitability for purpose. The conclusions drawn from acoustic test results are as interpreted by qualified independent testing authorities. Nothing here releases the purchaser/user from responsibility to determine the suitability of the product for their project needs. Always seek the opinion of your acoustic, mechanical or fire engineer on data presented by the manufacturer. Due to the wide variety of individual projects, Pyrotek is not responsible for differing outcomes from using their products. Pyrotek disclaims any liability for damages or consequential loss as a result of reliance solely on the information presented. No warranty is made that the use of this information or of the products, processes or equipment to which this Information Page refers will not infringe any third party's patents or rights. **DISCLAIMER:** This document is covered by Pyrotek standard Disclaimer, Warranty and © Copyright clauses. See pyroteknc.com/disclaimer